

**INSTRUCTION
MANUAL**

ATyS *g*

Automatic Transfer Switching Equipment

EN



www.socomec.com/en/documentation-atys-g



1. GENERAL SAFETY INSTRUCTIONS	6
2. INTRODUCTION	7
3. THE ATYS FAMILY PRODUCT RANGE	8
3.1. THE ATYS RANGE KEY FEATURES	8
4. QUICK START	10
4.1. QUICK START ATYS G FRAME B3 TO B5 (125A TO 630A)	10
4.1. QUICK START ATYS G FRAME B3 TO B5 (125A TO 630A) CONTINUED	12
4.2. QUICK START ATYS G FRAME B6 TO B8 (800A TO 3200A)	14
4.2. QUICK START ATYS G FRAME B6 TO B8 (800A TO 3200A) CONTINUED	16
5. GENERAL OVERVIEW	18
5.1. PRODUCT INTRODUCTION	18
5.2. PRODUCT IDENTIFICATION	19
5.3. ATS CONTROL MODULE INTERFACE	20
5.4. ENVIRONMENTAL	21
5.4.1. IP RATING	21
5.4.2. OPERATING CONDITIONS	21
5.4.3. STORAGE CONDITIONS	21
5.4.4. VOLUME AND SHIPPING WEIGHTS BY REFERENCE ATYS G	22
5.4.5. CE MARKING	23
5.4.6. LEAD FREE PROCESS	23
5.4.7. WEEE	23
5.4.8. EMC STANDARD	23
5.5. ATYS G ACCESSORIES AVAILABLE	24
6. INSTALLATION	25
6.1. PRODUCT DIMENSIONS	25
6.1.1. DIMENSIONS: FRAME B3 TO B5 (125A TO 630A)	25
6.1.2. DIMENSIONS: FRAME B6 & B7 (800A TO 1600A)	26
6.1.3. DIMENSIONS: FRAME B8 (2000A TO 3200A)	27
6.2. MOUNTING ORIENTATION	28
6.3. ASSEMBLY OF CUSTOMER MOUNTED ACCESSORIES	28
6.3.1. BRIDGING BAR INSTALLATION	28
6.3.2. TERMINAL SHROUDS	29
6.3.3. TERMINAL SCREENS	29
6.3.4. COPPER BAR CONNECTION KITS (2000A TO 3200A : FRAME B8)	30
6.3.5. INCOMING COPPER BAR CONNECTION KIT ASSEMBLY	31
6.3.6. OUTGOING BRIDGE CONNECTION ASSEMBLY	31
6.3.7. POWER SUPPLY	32
6.3.8. RAISED MOUNTING SPACERS	32

6.3.9. PADLOCKING KEY INTERLOCKS	32
6.3.10. ADDITIONAL AUXILIARY CONTACTS	33
7. CONNECTIONS	34
7.1. POWER CIRCUITS	34
7.1.1. CABLE OR BAR CONNECTIONS	34
7.1.2. POWER CONNECTION TERMINALS	34
7.1.3. POWER CONNECTION CROSS-SECTION	34
7.1.4. CONNECTION	35
7.2. NETWORKS AND POWER CONNECTION POSSIBILITIES	36
7.2.1. TYPE OF NETWORKS	36
7.2.2. METERING AND SENSING DETAILS	37
7.3. CONTROL CIRCUITS	38
7.3.1. TYPICAL ATYS G WIRING	38
7.3.2. ATYS G INPUT AND OUTPUT CONTACTS	39
7.4. VOLTAGE SENSING AND POWER SUPPLY KIT	42
7.4.1. STANDARD CONFIGURATION	42
7.4.2. SENSING KIT WIRING DIAGRAM (STANDARD)	43
7.4.3. NETWORK	44
8. ATYS G OPERATING MODES	45
8.1. MANUAL OPERATION	46
8.1.1. EMERGENCY MANUAL OPERATION	46
8.1.2. PADLOCKING	46
8.2. ELECTRICAL OPERATION	46
8.2.1. DUAL POWER SUPPLY	46
8.2.2. VOLTAGE SENSING INPUTS	47
8.2.3. FIXED INPUTS	48
8.2.4. FIXED OUTPUTS - DRY CONTACTS	50
8.3. PROGRAMMING	52
8.3.1. STEP 1: ATYS G DIP SWITCH SETTING OPTIONS	53
8.3.2. STEP 2: ATYS G POTENTIOMETER SETTING OPTIONS	53
8.3.3. STEP 3: ATYS G AUTO CONFIGURATION	54
8.3.4. STEP 4: SAVING THE CONFIGURED VALUES	55
8.3.5. STEP 5: PUTTING THE ATYS G INTO AUTO OPERATION	55
9. CHARACTERISTICS	56
10. PREVENTIVE MAINTENANCE	58
11. TROUBLE SHOOTING GUIDE	59
12. ACCESSORIES	60
12.1. TERMINAL SHROUDS	60
12.2. TERMINAL SCREENS	60
12.3. BRIDGING BARS	60
12.4. COPPER BAR CONNECTION KITS	61

12.5. SOLID NEUTRAL61
12.6. AUTOTRANSFORMER 400/230 VAC61
12.7. DC POWER SUPPLY62
12.8. VOLTAGE SENSING AND POWER SUPPLY KIT62
12.9. VOLTAGE RELAY62
12.10. DOOR PROTECTIVE SURROUND62
12.11. AUXILIARY CONTACTS (ADDITIONAL).....	.63
12.12. MOUNTING SPACERS63
12.13. 3 POSITION PADLOCKING (I - 0 - II).....	.63
12.14. RONIS KEY INTERLOCKING SYSTEM63
12.15. REMOTE INTERFACE64
12.16. CONNECTION CABLE FOR REMOTE INTERFACE64
12.17. SEALABLE COVER64
12.18. AUTO/MANUAL KEY SELECTOR64
13. SPARE PARTS65
13.1. ELECTRONIC MODULE65
13.2. MOTORISATION MODULE.....	.65
13.3. POWER SECTION65
14. ATYS FAMILY: ORDERING INFORMATION66

1. GENERAL SAFETY INSTRUCTIONS

- This manual provides instructions on safety, connections and operation of the ATyS g motorised changeover switch manufactured by SOCOMEC.
- Whether the ATyS g is sold as a loose product, as a spare, as an enclosed solution or as any other configuration, this device must always be installed and commissioned by qualified and experienced personnel, in line with the manufacturers recommendations, following good engineering practices and after having read and understood the details in the latest release of the relative product instruction manual.
- Maintenance on the product and any other associated equipment including but not limited to servicing operations must be performed by adequately trained and qualified personnel.
- Each product is shipped with a label or other form of marking including rating and other important specific product information. One must also refer to and respect markings on the product prior to installation and commissioning for values and limits specific to that product.
- Using the product outside the intended scope, outside SOCOMEC recommendations or outside the specified ratings and limits can cause personal injury and/or damage to equipment.
- This instruction manual must be made accessible so as to be easily available to anyone who may need to read it in relation with the ATyS g.
- The ATyS g meets the European Directives governing this type of product and includes CE marking on each product.
- No covers on the ATyS g should be opened (with or without voltage) as there may still be dangerous voltages inside the product such as those from external circuits.
- **Do not handle any control or power cables connected to the ATyS g when voltage may be present on the product directly through the mains or indirectly through external circuits.**
- Voltages associated with this product may cause injury, electric shock, burns or death. Prior to carry out any maintenance or other work on live parts or other parts in the vicinity of exposed live parts, ensure that the switch including all control and associated circuits are de-energized.

 DANGER	 WARNING	 CAUTION
RISK: Electric shock, burns, death	RISK: Possible personal injury	RISK: Equipment damage

- As a minimum the ATyS g comply with the following international standards:
 - IEC 60947-6-1
 - GB 14048-11
 - EN 60947-6-1
 - VDE 0660-107
 - BS EN 60947-6-1
 - NBN EN 60947-6-1
 - IEC 60947-3
 - IS 13947-3
 - EN 60947-3
 - NBN EN 60947-3
 - BS EN 60947-3

The information provided in this instruction manual is subject to change without notice, remains for general information only and is non-contractual.

2. INTRODUCTION

ATyS g “Automatic Transfer Switching Equipment” (ATSE) is designed for use in power systems for the safe transfer of a load supply between a normal and an alternate source. The changeover is done in open transition and with minimum supply interruption during transfer ensuring full compliance with IEC 60947-6-1, GB 14048-11 and other international TSE standards as listed.

The ATyS g is a full load break (switch type) derived transfer switching equipment where the main components are proven technology devices also fulfilling requirements in IEC 60947-3 standards.

As a Class PC ATSE, the ATyS g is capable of “making and withstanding short circuit currents” assigned to IEC 60947-3 utilization categories of up to AC23A, GB 14048-11, IEC 60947-6-1 and equivalent standards with utilization categories of up to AC33B.

ATyS g motorised source changeover switches ensure:

- Power Control and Safety between a normal and an alternate source.
 - A complete product delivered as a fully assembled and tested solution.
 - Intuitive HMI for emergency / local operation.
 - Integrated and robust switch disconnection.
 - Window with clearly visible position indication I – 0 - II.
 - An inherent failsafe mechanical interlock.
 - Stable positions (I – 0 – II) non affected by typical vibration and shocks.
 - Constant pressure on the contacts non effected by network voltage.
 - Energy Efficient with virtually no consumption whilst on the normal, alternate or off positions.
 - Quick, easy and safe dual “on-load” emergency manual operation.
(Manual operation is functional with and without the motorization in place).
 - Extremely rugged, error free and built in padlocking facility.
 - Straight forward installation with effective ergonomics.
 - Minimal downtime with the possibility to perform easy maintenance.
 - Simple and secure motorization controls interface with remote control.
 - Straightforward ATS configuration for easy and fast commissioning.
 - Integrated switch position auxiliary contacts.
 - Dual active “product availability” status feedback for motorisation and ATS controllers.
 - Ample accessories to suit specific requirements.
 - Fully integrated ATS controller specifically designed for Mains / Genset Applications.
- Power supply continuity for most mains / genset network applications...

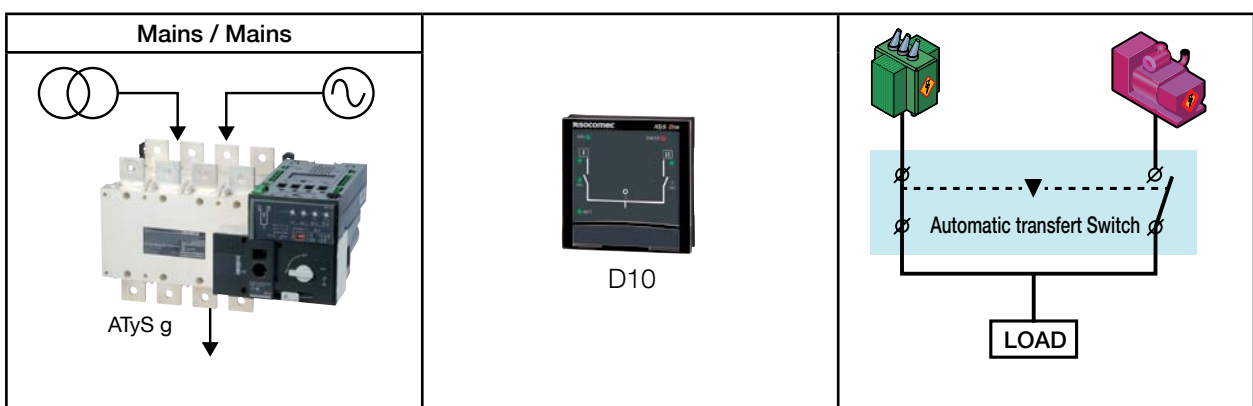

3. THE ATyS FAMILY PRODUCT RANGE

The ATyS g has been engineered by the SOCOMEC centre of excellence in France who boasts it's very own in-house 100MVA instantaneous power test lab accredited by COFRAC and working in partnership with: KEMA, CEPEC, UL, CSA, ASTA, Lloyd's Register of Shipping, Bureau Veritas, BBJ-SEP, EZU, GOST-R... and others.





SOCOME C has been manufacturing power control and safety products since 1922. The first generation SOCOMEC "motorised changeover switches" were introduced in 1990 and today the ATyS brand has become trusted by major players in the power industry worldwide.

The ATyS Family includes a complete range of remotely operated transfer switch equipment (RTSE) as well as automatic fully integrated products and solutions (ATSE). Selecting the right ATyS will depend on the application as well as the nature of installation in which the ATyS will be installed.

This instruction manual includes details and instructions specific to the "ATyS g" ATSE only. For all other ATyS family of products please refer to the specific instruction manual related to that product. (Available for download on www.socomec.com)

An overview of the complete ATyS range is presented below:
(The encircled device is the product detailed in this instruction manual).

Just the right ATyS for your application...

ATyS: Small Footprint	ATyS M: Modular Profile
<p>Back to Back Configuration</p>  <p>125A - 3200A ↑</p> <p>new</p>  <p>40A - 125A ↑</p> <p>ATyS p Power/Genset Management</p> <p>ATyS g Simple Genset Management</p> <p>ATyS t Transformer Management</p> <p>ATyS d S Small Genset with DPS</p> <p>ATyS d RTSE (DPS)</p> <p>ATyS S (RTSE) Small Genset</p> <p>ATyS r (1) ATyS  RTSE RTSE</p>	 <p>40A - 160A ↑</p> <p>ATyS p M Evolved Genset Management</p> <p>ATyS g M Simple Genset Management</p> <p>ATyS t M Transformer (building) Management</p> <p>ATyS d M RTSE (DPS)</p> <p>Side by Side Configuration</p>

(1) The UL version of ATyS r is available from 100 - 400A

3.1. The ATyS Range Key Features

Selecting the right ATyS will depend on the application, the functionality required as well as the nature of the installation in which the ATyS will be installed. Below is an outline product selection chart listing the key features of each product to help to select the right ATyS for your needs.

IEC 60947-6-1	ATyS S	ATyS Sd	ATyS r	ATyS d	ATyS t	ATyS g	ATyS p
UL 1008			ATyS (UL)				
Motorised Changeover with control driven by dry contacts	•	•	•	•	•	•	•
Manual Emergency Operation with external handle	•	•	•	•	•	•	•
Wide band AC control voltage supply	•	•	•	•	•	•	•
Wide band DC control voltage supply	•						
Watchdog relay to ensure product availability			•	•	•	•	•
Ratings from 40 – 125A as indicated or 125A - 3200A for •	40 – 125A	40 – 125A	UL 100 – 400A	•	•	•	•
Override controls and force switch to zero (off) position			•	•	•	•	•
Integrated position auxiliary contacts (I - O - II)	•	•	•	•	•	•	•
Source availability LED display				•	•	•	•
Remote Display module RJ45 connection for D10				•	•	•	
Integrated Dual power supply		•		•	•	•	•
Network - Network Applications	•	•	•	•	•		•
Network - Genset Applications	•	•	•	•		•	•
Genset - Genset Applications	•	•	•	•			
Pre-defined fixed I/O			• 5/1	• 5/1	• 9/2	• 11/3	• 5/2
Programmable I/O							• 6/1
Additional programmable I/O modules (Optional up to 4 modules)							• 8/8
Remotely operated Transfer Switching Equipment (RTSE Class PC)	•	•	•	•			
Automatic Transfer Switching Equipment (ATSE Class PC)					•	•	•
Remote + Manual Control	•	•	•	•			
Auto + Remote + Manual Control					•	•	
Auto + Remote + Local + Manual Control							•
Auto-configuration of voltage and frequency levels					•	•	•
Switch Position LED display					•	•	•
Security Sealing Cover					•	•	
Configuration through potentiometers and dip switches					•	•	
Test on load functionality						•	•
Test off load functionality						•	•
Programmable configuration with keypad and LCD display							•
Metering & Measurement: kW; kVar; kVA + kWh; kVarh; kVAh							•
Communication RS485 + Ethernet + Ethernet gateway (Optional)							•
Webserver Access through optional Ethernet module (Optional)							•
Easy Configuration software (Through Ethernet/Modbus)							•
Remote Terminal Unit RJ45 connection for D20							•
Data Logger for Event Recording with RTC (Through Ethernet/Modbus)							•
Programmable Engine Exerciser functionality (Through Ethernet/Modbus)							•
Multi level password access							•
Load Shedding function							•
Capacity Management functionality							•
Peak shaving functionality							•
4 - 20mA communication module (Optional)							•
KWh Pulsed output module (Optional)							•
Counters KWh, permutation...							•
LCD display for programming, metering, timers and counters							•
Possibility to add optional functionality							•

4. QUICK START

4.1. Quick Start ATyS g Frame B3 to B5 (125A to 630A)



QUICK START EN 125A - 630A

ATyS g

Motorised Source Changeover Switch
Automatic Transfer Switching Equipment

Preliminary operations

Check the following upon delivery and after removal of the packaging:

- Packaging and contents are in good condition.
- The product reference corresponds to the order.
- Contents should include:
 - Qty 1 x ATyS g
 - Qty 1 x Emergency handle and fixing clip
 - Quick Start instruction sheet

Warning

⚠ Risk of electrocution, burns or injury to persons and / or damage to equipment.

This Quick Start is intended for personnel trained in the installation and commissioning of this product. For further details refer to the product instruction manual available on the SOCOMECE website.

- This product must always be installed and commissioned by qualified and approved personnel.
- Maintenance and servicing operations should be performed by trained and authorised personnel.
- Do not handle any control or power cables connected to the product when voltage may be, or may become present on the product, directly through the mains or indirectly through external circuits.
- Always use an appropriate voltage detection device to confirm the absence of voltage.
- Ensure that no metal objects are allowed to fall in the cabinet (risk of electrical arcing).

Failure to observe good engineering practises as well as to follow these safety instructions may expose the user and others to serious injury or death.

⚠ Risk of damaging the device

- In case the product is dropped or damaged in any way it is recommended to replace the complete product.

Accessories

- Bridging bars and connection kits.
- Control voltage transformer (400Vac -> 230Vac).
- DC power supply (12/24Vdc -> 230Vac).
- Mounting spacers to raise the product x 10mm.
- Phase barriers.
- Terminal shrouds.
- Terminal screens.
- Auxiliary contacts (Additional).
- Padlocking in 3 positions (I - 0 - II).
- Lockout accessories (RONIS - EL 11 AP).
- Door escutcheon frame.
- ATyS D10 Interface (remote display).
- Voltage sensing kit.
- Sealable cover.
- RJ45 cable for ATyS D10 => ATyS g

For further details refer to the product instruction manual under chapter "Spares and Accessories"



www.socomec.com
To download, brochures, catalogues and technical manuals:
<http://www.socomec.com/en/documentation-atys-g>

Printing informations: 1 color Black, White paper 90g/m².
Printing size: 420x297. Final size 210x297. This page visible first.
CORPORATE HQ CONTACT:
SOCOMECE SAS, 1-4 RUE DE WESTHOUSE, 67235 BENFELD, FRANCE



Non contractual document.
Subject to change without notice.

541 996 E - 10/16 - EN

Installation and Commissioning

STEP 1
Cabinet / Back Plate Installation

STEP 2
Power Terminal Connections

STEP 3
COMMAND / CONTROL terminal connections

STEP 4
Power SUPPLY and ATS Controller Terminal Connections

STEP 5
CHECK

STEP 6
PROGRAMMING

STEP 7A
AUT Mode (Automatic Control)

STEP 7B
AUT Mode (Remote Control)

STEP 7C
Manual Mode

STEP 7D
Padlocking Mode

STEP 4 Power Supply, Sensing and Control wiring (ATS Controller)

Connect the product with a cable of section of 1,5 to 2,5 mm².
Screw M3 - Tightening torque: min.: 0.5 Nm - max.: 0.6 Nm

<p>ATS Power Supply Input II Power supply II - L/N Power supply II - N/L 208-277 VAC ±20%: 50/60 Hz</p>	<p>ATS Voltage Sensing Input Source supply II S II - Phase / Neutral S II - Phase S II - Phase 575 VAC (ph-ph) max S II - Neutral / Phase 332 VAC (ph-n) max</p>	<p>ATS Power Supply Input I Power supply I - L/N Power supply I - N/L 208-277 VAC ±20%: 50/60 Hz</p>	<p>ATS Voltage Sensing Input Source supply I S I - Phase / Neutral S I - Phase S I - Phase 575 VAC (ph-ph) max S I - Neutral / Phase 332 VAC (ph-n) max</p>
<p>ATS Module Control Inputs (Fixed)</p>	<p>ATS Module Control Inputs (Fixed)</p>	<p>ATS Module Output Contact (Product available)</p>	<p>Remote interface RJ45 - to ATyS D10</p>

STEP 1

Installation

Caution: Ensure that the product is installed on a flat rigid surface.

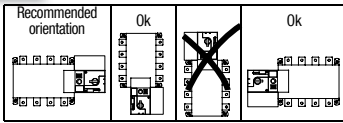

Door cut-out for front panel.

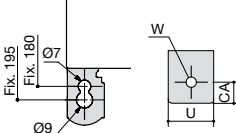
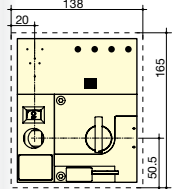

Dimensions in mm.

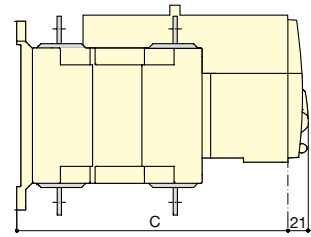
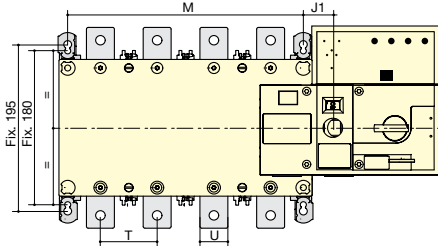

	125 A		160 A		200 A		250 A		315 A		400 A		500 A		630 A	
	3 P	4 P	3 P	4 P	3 P	4 P	3 P	4 P	3 P	4 P	3 P	4 P	3 P	4 P	3 P	4 P
J 1	34	34	34	34	34	34	35	35	35	35	35	35	34	34	34	34
M	120	150	120	150	120	150	160	210	160	210	160	210	210	270	210	270
T	36	36	36	36	36	36	50	50	50	50	50	50	65	65	65	65
C	244	244	244	244	244	244	244	244	244	244	244	244	320	320	320	320
U	20	20	20	20	20	20	25	25	35	35	35	35	32	32	45	45
W	9	9	9	9	9	9	11	11	11	11	11	11	13	13	13	13
CA	10	10	10	10	10	10	15	15	15	15	15	15	20	20	20	20

STEP 2

Power Terminal Connections

To be connected using terminal lugs, rigid or flexible busbars.

	FRAME B3			FRAME B4			FRAME B5	
	125 A	160 A	200 A	250 A	315 A	400 A	500 A	630 A
Minimum cable section Cu (mm ²) at lth (IEC 60947-1)	35	35	50	95	120	185	2x95	2x120
Recommended cable section Cu (mm ²) at lth	-	-	-	-	-	-	2x30x5	2x40x5
Maximum cable section Cu (mm ²)	50	95	120	150	240	240	2x185	2x300
Maximum Cu busbar width (mm)	25	25	25	32	32	32	50	50
Type of screw	M8	M8	M8	M10	M10	M10	M12	M12
Recommended tightening torque (N.m)	8.3	8.3	8.3	20	20	20	40	40
Maximum tightening torque (N.m)	13	13	13	26	26	26	45	45

Example: Control wiring for a 400VAC application having a 3 phase and neutral supply.

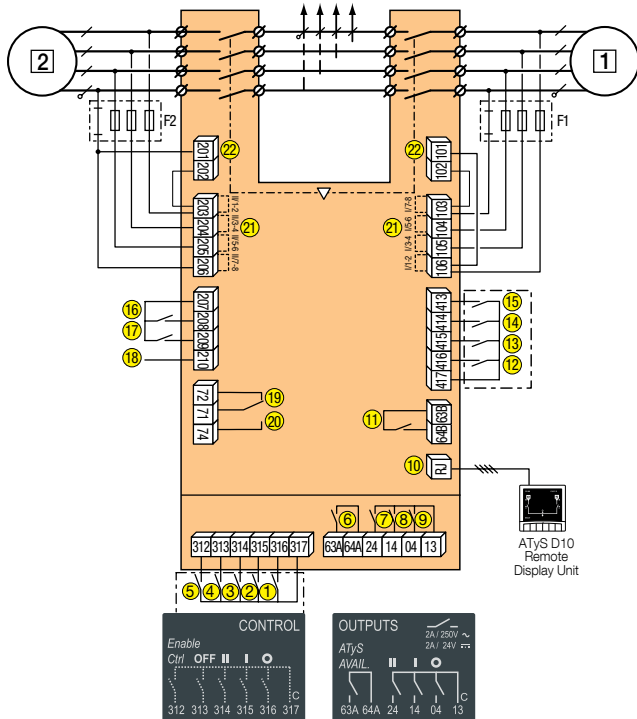

STEP 3

CONTROL / COMMAND Terminals

Ensure that the product is in Manual Mode.

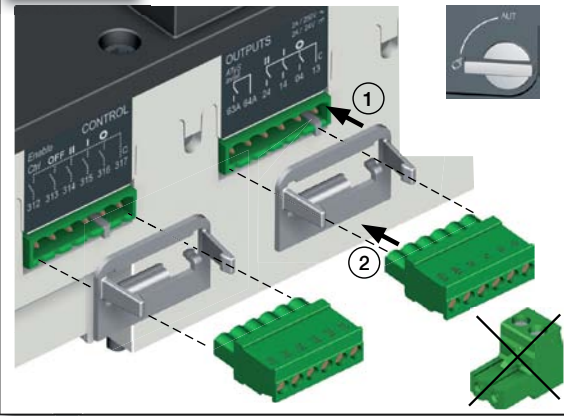

- 1 preferred source
- 2 alternate source
- 1. Position 0 order
- 2. Position 1 order
- 3. Position 2 order
- 4. Zero position priority order
- 5. Remote Control Enable (Priority over Auto)
- 6. Product Available output (Motor)
- 7. Position II aux contact
- 8. Position I aux contact
- 9. Position 0 aux contact
- 10. O/P to ATyS D10 remote display
- 11. Product Available output (ATS)
- 12. I/P Inhibition of the ATS controls
- 13. I/P Manual retransfer
- 14. S2 Stability Time Bypass: 2AT
- 15. M-G: Priority to TON / M-M: Priority enable/disable
- 16. TEST OFF LOAD Signal : TOF
- 17. M-G: Test On Load Input (TON) / M-M: Priority source selection
- 18. Not used
- 19. Contact "Start/Stop Genset" : if S1 is not available the NC contact (71-72) is close
- 20. Contact "Start/Stop Genset" : if S1 is not available the NO contact (71-74) is open
- 21. Voltage Sensing Inputs
- 22. Power Supply Inputs

4.1. Quick Start ATyS g Frame B3 to B5 (125A to 630A) continued

STEP 5

Check
Whilst in manual mode, check the wiring and if ok power up the product.

LED "Power" Green: ON
LED Manual/Fault Red: ON

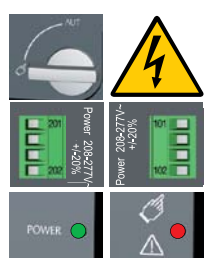

STEP 6

Programming the ATyS g

The ATyS g is programmed after wiring verification tests through the front of the ATS Controller in 5 steps:

Note: Ensure that the ATyS g is in "Manual Mode", powered and with at least one network supply available.

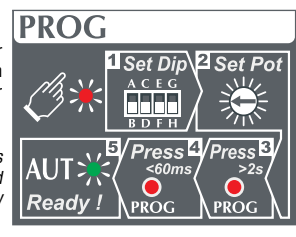

WARNING As a safety measure the READY LED will flash when any of the settings shown on the controller are different to those that are saved. To return to the steady READY LED revert to the saved setting values or save the displayed value by pressing the PROG OK button briefly. (This is intended as a visual alarm in case one has changed the configuration settings but has not yet saved the new values in the product). For added security the ATyS g may be equipped with a sealable cover so as to limit the access to configuration settings. Refer to the product accessory section for details.

1 Set Dip Dip Switch Setting Options

SET the 4 Dip Switches using a small screw driver. Possible variants vary from positions "A to H" as described in the table below. For convenience, the position functions are also described on the front of the ATS controller adjacent to the dip switches.

Note: The READY LED will flash green as soon as settings are changed and until the new settings have been saved by pressing the PROG OK button momentarily.

Dip Switch Setting Options		
Dipswitch 1 A / B	A	Three Phase Network
	B	Single Phase Network (Attn : Dipswitch 2 is inactive in this position)
Dipswitch 2 C / D	C	Three Phase 4 wire Network (Including Neutral) (Allows to detect a loss of neutral for unbalanced loads)
	D	Three Phase 3 wire Network (Without Neutral)
Dipswitch 3 E / F	E	Load supply down time of 0 second (ODT = 0 sec)
	F	Load supply down time of 2 seconds (ODT = 2 sec)
Dipswitch 4 G / H	G	Main - Generator Application
	H	Main - Main Application

3 Press 3 >2s Auto Configuration of Mains Voltage and Frequency

If the 1st potentiometer is not on "Auto Conf", go to STEP 4.

The ATyS g includes an "Auto Configuration" feature to detect the mains voltage and frequency nominal values, phase rotation and neutral position and saves them in the ATS controller.

Note: Before configuring the nominal values ensure that the product is properly wired, verified and ready for commissioning. It is imperative that the network supply is available and that the wiring to the ATyS g voltage sensing terminals 103 – 106 and 203 – 206 has been done. It is preferable to use the ATyS sensing kit that may be provided as an accessory.

- Press and hold the Red "PROG OK" button for >2s to measure the mains voltage and frequency.

Note: The source available LED will flash while the available network is being measured. The READY LED will flash green as soon as settings are measured and until these settings have been saved by pressing the PROG OK button a second time momentarily. (Refer to STEP 4).

2 Set Pot Potentiometer Setting Options

SET the 4 potentiometers using a small screw driver paying attention to the arrow indicating the position. There are a total of 14 positions for which the specific settings are described in the table below.

Note: The READY LED will flash green as soon as settings are changed and until the new settings have been saved by pressing the PROG OK button momentarily.

Un	N°	PP / PN	N°	ΔU	ΔF %
50 Hz	1:	220 / 127	1:	5	3
	2:	380 / 220	2:	6	3
	3:	400 / 230	3:	7	4
	4:	415 / 240	4:	8	4
	5:	480 / 277	5:	9	5
60 Hz	6:	208 / 120	6:	10	6
	7:	220 / 127	7:	11	6
	8:	230 / 132	8:	12	7
	9:	240 / 138	9:	13	7
	10:	380 / 220	10:	14	7
	11:	400 / 230	11:	15	8
	12:	415 / 240	12:	16	8
	13:	415 / 240	13:	18	9
	14:	480 / 277	14:	20	10

4 Press 4 <60ms Saving the configured values

To SAVE the recorded setting configuration press the PROG OK button momentarily: <60ms.

Note: The flashing READY LED goes off once the values are saved in the ATS controller. At least one of the source availability LED must be ON.

WARNING Whatever Pot 1 trimming, it is IMPERATIVE to set Pots 2 to 4.

Potentiometer	Position	Configuration														
		Auto Conf	1	2	3	4	5	6	7	8	9	10	11	12	13	
Un	PP / PN	Mesured	220 / 380 / 400 / 415 / 480 / 208 / 220 / 230 / 240 / 380 / 400 / 415 / 480 / 127V 220V 230V 240V 277V 120V 127V 132V 138V 220V 230V 240V 277V													
	F	50Hz														
	Position	1	2	3	4	5	6	7	8	9	10	11	12	13	14	
ΔU / ΔF	U threshold in % of Un	5%	6%	7%	8%	9%	10%	11%	12%	13%	14%	15%	16%	18%	20%	
	F threshold in % of Fn	3%	3%	4%	4%	5%	5%	6%	6%	7%	7%	8%	8%	9%	10%	
	Hysteresis	20% of ΔU / ΔF settings														
FT	Source Failure Timer (s)	0	1	2	3	4	5	8	10	15	20	30	40	50	60	
RT	Source Return Timer (min)	0	1	2	3	4	5	8	10	15	20	30	40	50	60	

5 AUT Ready! Putting the ATyS g into Auto Operation

After following Steps 1 to 4, and once ready to put the ATyS g into AUTO operation turn the mode selector switch to Auto.

Note: When the product is powered and properly configured, after switching the product from Manual Mode to Auto Mode the READY light should be a steady green light.

WARNING Depending on the state of the ATyS g the ATS automation may change the switch position as soon as the mode selector is switched to AUT. This is a normal operation.

4.2. Quick Start ATyS g Frame B6 to B8 (800A to 3200A)



QUICK START EN 800A - 3200A

ATyS g

Motorised Source Changeover Switch
Automatic Transfer Switching Equipment

Preliminary operations

Check the following upon delivery and after removal of the packaging:

- Packaging and contents are in good condition.
- The product reference corresponds to the order.
- Contents should include:
 - Qty 1 x ATyS g
 - Qty 1 x Emergency handle and fixing clip
 - Quick Start instruction sheet

Warning

⚠ Risk of electrocution, burns or injury to persons and / or damage to equipment.

This Quick Start is intended for personnel trained in the installation and commissioning of this product. For further details refer to the product instruction manual available on the SOCOMEC website.

- This product must always be installed and commissioned by qualified and approved personnel.
- Maintenance and servicing operations should be performed by trained and authorised personnel.
- Do not handle any control or power cables connected to the product when voltage may be, or may become present on the product, directly through the mains or indirectly through external circuits.
- Always use an appropriate voltage detection device to confirm the absence of voltage.
- Ensure that no metal objects are allowed to fall in the cabinet (risk of electrical arcing).

Failure to observe good engineering practises as well as to follow these safety instructions may expose the user and others to serious injury or death.

⚠ Risk of damaging the device

- In case the product is dropped or damaged in any way it is recommended to replace the complete product.

Accessories

- Bridging bars and connection kits.
- Control voltage transformer (400Vac -> 230Vac).
- DC power supply (12/24Vdc -> 230Vac).
- Mounting spacers to raise the product x 10mm.
- Phase barriers.
- Terminal shrouds.
- Terminal screens.
- Auxiliary contacts (Additional).
- Padlocking in 3 positions (I - 0 - II).
- Lockout accessories (RONIS - EL 11 AP).
- Door escutcheon frame.
- ATyS D10 Interface (remote display).
- Voltage sensing kit.
- Sealable cover.
- RJ45 cable for ATyS D10 => ATyS g

For further details refer to the product instruction manual under chapter "Spares and Accessories"



www.socomec.com
To download, brochures, catalogues and technical manuals:
<http://www.socomec.com/en/documentation-atys-g>

Printing informations: 1 color Black, White paper 90g/m².
Printing size: 420x297. Final size 210x297. This page visible first.
CORPORATE HQ CONTACT:
SOCOMEC SAS, 1-4 RUE DE WESTHOUSE, 67235 BENFELD, FRANCE



Non contractual document.
Subject to change without notice.

541 997 F - 10/16 - EN

Installation and Commissioning

STEP 1
Cabinet / Back Plate Installation

STEP 2
Power Terminal Connections

STEP 3
COMMAND / CONTROL terminal connections

STEP 4
Power SUPPLY and ATS Controller Terminal Connections

STEP 5
CHECK

STEP 6
PROGRAMMING

STEP 7A
AUT Mode (Automatic Control)

STEP 7B
AUT Mode (Remote Control)

STEP 7C
Manual Mode

STEP 7D
Padlocking Mode

STEP 4 Power Supply, Sensing and Control wiring (ATS Controller)

Connect the product with a cable of section of 1,5 to 2,5 mm².
Screw M3 - Tightening torque: min.: 0.5 Nm - max.: 0.6 Nm

ATS Power Supply Input II
Power supply II - L/N
Power supply II - N
208-277 VAC ±20%:
50/60 Hz

ATS Voltage Sensing Input Source supply II
S II - Phase 1
S II - Phase 2
S II - Phase 3
575 VAC (ph-ph) max
S II - Neutral
332 VAC (ph-n) max

ATS Module Control Inputs (Fixed)

Genset Start/Stop Signal

ATS Power Supply Input I
Power supply I - L/N
Power supply I - N
208-277 VAC ±20%:
50/60 Hz

ATS Voltage Sensing Input Source supply I
S I - Phase 1
S I - Phase 2
S I - Phase 3
575 VAC (ph-ph) max
S I - Neutral
332 VAC (ph-n) max

ATS Module Control Inputs (Fixed)

ATS Module Output Contact (Product available)

Remote interface RJ45 - to ATyS D10

Recommended to use SOCOMEC Voltage Sensing Kit (refer to ATyS g accessories for details)

STEP 1

Installation

Caution: Ensure that the product is installed on a flat rigid surface.

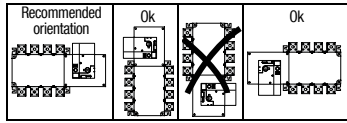

Door cut-out for front panel.

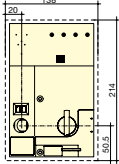

ATyS g 800 to 1000 A

ATyS g 1250 A

ATyS g 1600 to 3200 A

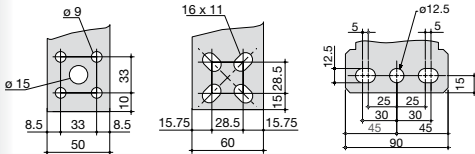

Dimensions in mm.

	800 A		1000 A		1250 A		1600 A		2000 A		2500 A		3200 A	
	3 P	4 P	3 P	4 P	3 P	4 P	3 P	4 P	3 P	4 P	3 P	4 P	3 P	4 P
M	255	335	255	335	255	335	347	467	347	467	347	467	347	467
T	80	80	80	80	80	80	120	120	120	120	120	120	120	120
C	391	391	391	391	391	391	391	391	523	523	523	523	523	523

STEP 2

Power Terminal Connections

To be connected using terminal lugs, rigid or flexible busbars.

	FRAME B6			FRAME B7		FRAME B8	
	800 A	1000 A	1250 A	1600 A	2000 A	2500 A	3200 A
Minimum cable section Cu (mm ²) at Ith (IEC 60947-1)	2x185	-	-	-	-	-	-
Recommended cable section Cu (mm ²) at Ith	2x50x5	2x60x5	2x60x7	2x100x5	3x100x5	4x100x5	3x100x10
Maximum cable section Cu (mm ²)	2x300	4x185	4x185	6x185	-	-	-
Maximum Cu busbar width (mm)	63	63	63	100	100	100	100
Type of screw	M8	M8	M10	M12	M12	M12	M12
Recommended tightening torque (N.m)	8.3	8.3	20	40	40	40	40
Maximum tightening torque (N.m)	13	13	26	45	45	45	45

Example: Control wiring for a 400VAC application having a 3 phase and neutral supply.

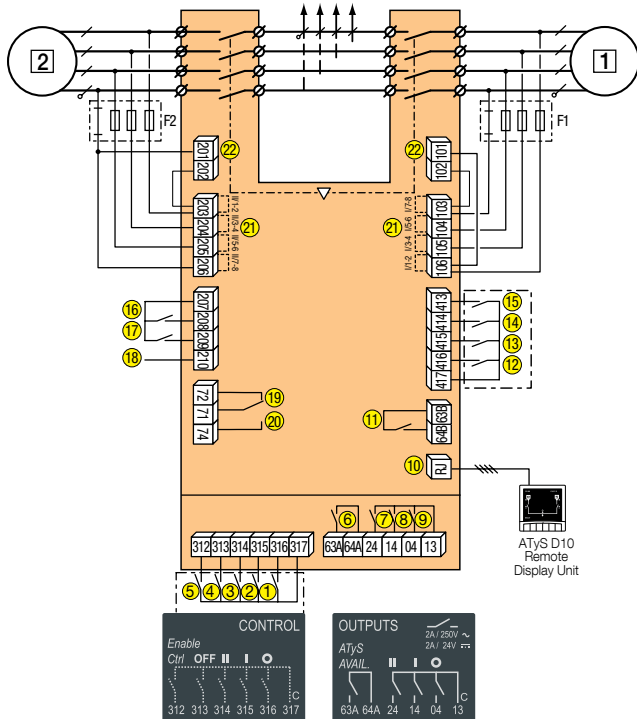

STEP 3

CONTROL / COMMAND Terminals

Ensure that the product is in Manual Mode.

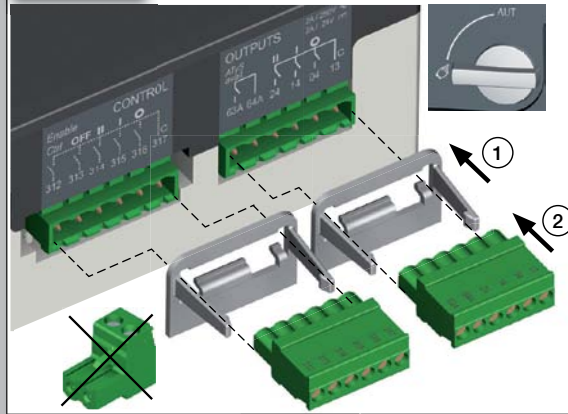

- 1 preferred source
- 2 alternate source
- 3 Position 0 order
- 4 Position 1 order
- 5 Remote Control Enable (Priority over Auto)
- 6 Product Available output (Motor)
- 7 Position II aux contact
- 8 Position I aux contact
- 9 Position 0 aux contact
- 10 O/P to ATyS D10 remote display
- 11 Product Available output (ATS)
- 12 I/P Inhibition of the ATS controls
- 13 I/P Manual retransfer
- 14 S2 Stability Time Bypass: 2AT
- 15 M-G: Priority to TON / M-M: Priority enable/disable
- 16 TEST OFF LOAD Signal : TOF
- 17 M-G: Test On Load Input (TON) / M-M: Priority source selection
- 18 Not used
- 19 Contact "Start/Stop Genset" : if S1 is not available the NC contact (71-72) is close
- 20 Contact "Start/Stop Genset" : if S1 is not available the NO contact (71-74) is open
- 21 Voltage Sensing Inputs
- 22 Power Supply Inputs

4.2. Quick Start ATyS g Frame B6 to B8 (800A to 3200A) continued

STEP 5

Check

Whilst in manual mode, check the wiring and if ok power up the product.

LED "Power" Green: ON
LED Manual/Fault Red: ON

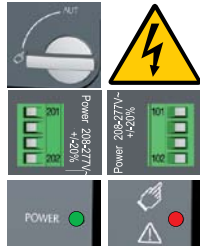

STEP 6

Programming the ATyS g

The ATyS g is programmed after wiring verification tests through the front of the ATS Controller in 5 steps:

Note: Ensure that the ATyS g is in "Manual Mode", powered and with at least one network supply available.

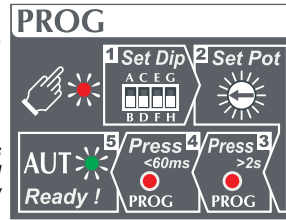

WARNING As a safety measure the READY LED will flash when any of the settings shown on the controller are different to those that are saved. To return to the steady READY LED revert to the saved setting values or save the displayed value by pressing the PROG OK button briefly. (This is intended as a visual alarm in case one has changed the configuration settings but has not yet saved the new values in the product). For added security the ATyS g may be equipped with a sealable cover so as to limit the access to configuration settings. Refer to the product accessory section for details.



Dip Switch Setting Options

SET the 4 Dip Switches using a small screw driver. Possible variants vary from positions "A to H" as described in the table below. For convenience, the position functions are also described on the front of the ATS controller adjacent to the dip switches.

Note: The READY LED will flash green as soon as settings are changed and until the new settings have been saved by pressing the PROG OK button momentarily.

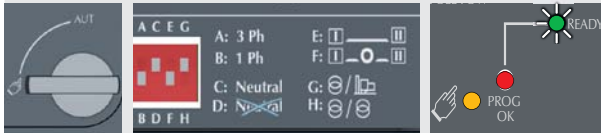

Dip Switch Setting Options

Dipswitch	Position	Function
Dipswitch 1 A / B	A	Three Phase Network
	B	Single Phase Network (Attn : Dipswitch 2 is inactive in this position)
Dipswitch 2 C / D	C	Three Phase 4 wire Network (Including Neutral) (Allows to detect a loss of neutral for unbalanced loads)
	D	Three Phase 3 wire Network (Without Neutral)
Dipswitch 3 E / F	E	Load supply down time of 0 second (ODT = 0 sec)
	F	Load supply down time of 2 seconds (ODT = 2 sec)
Dipswitch 4 G / H	G	Main - Generator Application
	H	Main - Main Application



Potentiometer Setting Options

SET the 4 potentiometers using a small screw driver paying attention to the arrow indicating the position. There are a total of 14 positions for which the specific settings are described in the table below.

Note: The READY LED will flash green as soon as settings are changed and until the new settings have been saved by pressing the PROG OK button momentarily.

Parameter	Position	Value
Un	1	220 / 127
	2	380 / 220
	3	400 / 240
	4	415 / 240
	5	480 / 277
ΔU	6	208 / 120
	7	220 / 127
	8	230 / 132
	9	240 / 138
	10	380 / 220
ΔF	11	400 / 230
	12	415 / 240
	13	480 / 277
	14	20
	15	10

WARNING Whatever Pot 1 trimming, it is IMPERATIVE to set Pots 2 to 4.

Potentiometer	Position	Configuration													
		1	2	3	4	5	6	7	8	9	10	11	12	13	
Un	PP / PN	220 / 380 / 400 / 415 / 480 / 208 / 220 / 230 / 240 / 380 / 400 / 415 / 480 / 127V 220V 230V 240V 277V 120V 127V 132V 138V 220V 230V 240V 277V													
	F	50Hz													
ΔU	U threshold in % of Un	5%	6%	7%	8%	9%	10%	11%	12%	13%	14%	15%	16%	18%	20%
	ΔF	F threshold in % of Fn	3%	3%	4%	4%	5%	5%	6%	6%	7%	7%	8%	8%	9%
FT	Hysteresis	20% of ΔU / ΔF settings													
	Source Failure Timer (s)	0	1	2	3	4	5	8	10	15	20	30	40	50	60
RT	Source Return Timer (min)	0	1	2	3	4	5	8	10	15	20	30	40	50	60



Auto Configuration of Mains Voltage and Frequency

If the 1st potentiometer is not on "Auto Conf", go to STEP 4.



The ATyS g includes an "Auto Configuration" feature to detect the mains voltage and frequency nominal values, phase rotation and neutral position and saves them in the ATS controller.

Note: Before configuring the nominal values ensure that the product is properly wired, verified and ready for commissioning. It is imperative that the network supply is available and that the wiring to the ATyS g voltage sensing terminals 103 – 106 and 203 – 206 has been done. It is preferable to use the ATyS sensing kit that may be provided as an accessory.

• Press and hold the Red "PROG OK" button for >2s to measure the mains voltage and frequency.

Note: The source available LED will flash while the available network is being measured. The READY LED will flash green as soon as settings are measured and until these settings have been saved by pressing the PROG OK button a second time momentarily. (Refer to STEP 4).

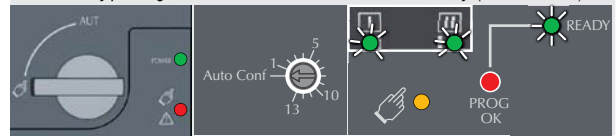

Saving the configured values

To SAVE the recorded setting configuration press the PROG OK button momentarily: <60ms.

Note: The flashing READY LED goes off once the values are saved in the ATS controller.

At least one of the source availability LED must be ON.

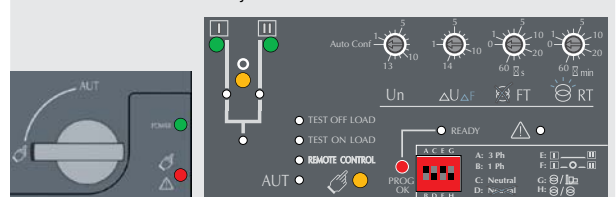

Putting the ATyS g into Auto Operation

After following Steps 1 to 4, and once ready to put the ATyS g into AUTO operation turn the mode selector switch to Auto.

Note: When the product is powered and properly configured, after switching the product from Manual Mode to Auto Mode the READY light should be a steady green light.

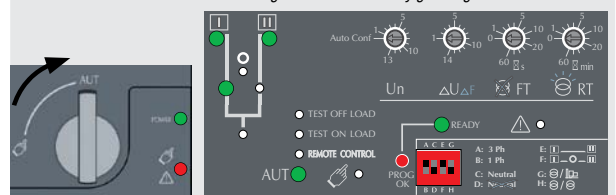

WARNING Depending on the state of the ATyS g the ATS automation may change the switch position as soon as the mode selector is switched to AUT. This is a normal operation.

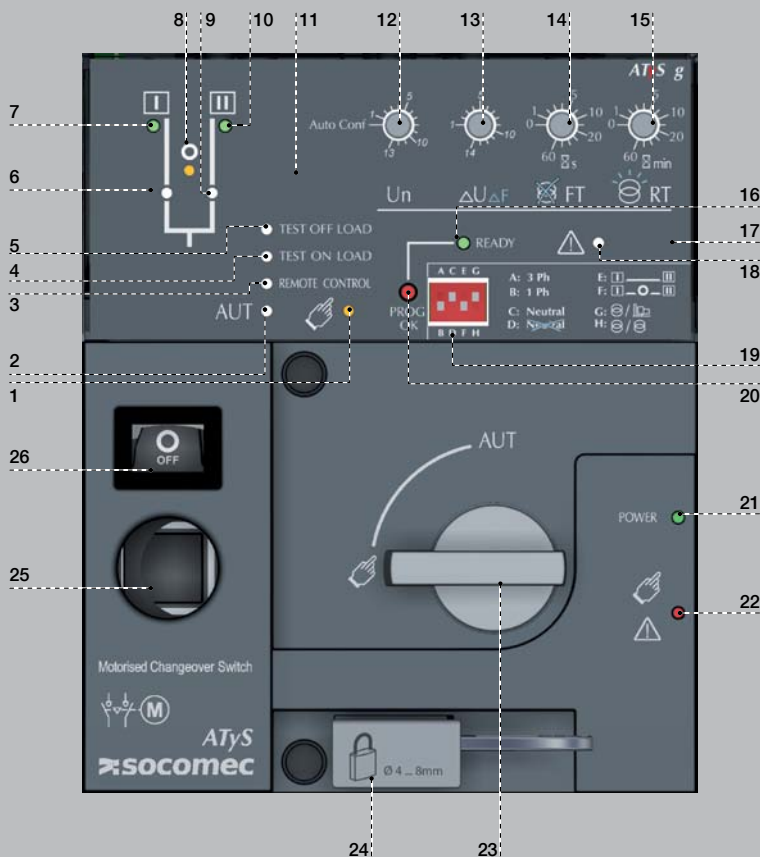

1. MANUAL Mode LED indication. (Yellow steady light when in Manual Mode).
2. AUTO Mode LED indication
Green steady light when in Auto mode with no timers running.
Green flashing light when in Auto with timers running in the background.
3. REMOTE CONTROL Mode LED indication. Yellow steady light when in remote control mode. Remote control mode is achieved with the Auto/Manu selector switched to Auto and terminals 312 closed with terminal 317. Remote control orders are received through closing 314 to 316 with 317.
4. TEST ON LOAD CONTROL Mode LED indication. (Yellow steady light when in TON mode)
5. TEST OFF LOAD CONTROL Mode LED indication. (Yellow steady light when in TOF mode).
6. Switch 1 LED position indication. (Green when in position 1).
7. Source supply I availability LED indication. (Green when supply I voltage is within the set limits).
8. Zero position LED indication. (Yellow when in position 0).
9. Switch 2 LED position indication. (Green when in position 2).
10. Source supply II availability LED indication. (Green when supply II voltage is within the set limits).
11. Sealing screw location 1 for use with sealing cover (Available as an accessory)
12. Potentiometer 1 : Network Configuration. (Auto Configuration or refer to the configuration guide sticker on the front of the ATyS g when using the predefined setting positions 1 to 13).
13. Potentiometer 2 : Voltage and Frequency threshold settings. (Refer to the configuration guide sticker on the front of the ATyS g to set the V / Hz threshold. Positions 1 to 14).
14. Potentiometer 3: Supply FAILURE Time (FT) Adjustable from 0 to 60 seconds.
15. Potentiometer 4: Supply RETURN Time (RT) Adjustable from 0 to 60 minutes.
16. READY LED indication
Green steady light : Product in AUTO, Watchdog OK, Product Available to changeover.
Green flashing: Settings displayed not saved or have been changed since last saved. (Press PROG OK button in manual mode to save or revert to last saved settings).
17. Sealing screw location 2 for use with the sealing cover.
18. FAULT LED indication. (Red steady light in case of an ATS controller internal fault).
19. Configuration dip switches : (4 dip switches with 2 positions in each A to H).
20. PROG OK: Configuration save push button. (ATTN: Active in Manual Mode ONLY). Press briefly to confirm and save all set configuration settings. Hold pressed for 2 seconds to set the network supply voltage and frequency by Auto Configuration. This is to be followed by pressing briefly to save the set value configured.
21. Green LED Indication: Power
22. Red LED Indication: Product Unavailable / Manual Mode / Fault Condition
23. Auto / Manual mode selector switch (Key version available as an option)
24. Padlocking facility (Up to 3 padlocks of dia. 4 – 8mm)
25. Emergency manual operation shaft location (Accessible only in manual mode)
26. Switch position indication window: I (On switch I) 0 (Off) II (On switch II).

STEP 7A

AUT Mode (Automatic Control)

Ensure that the emergency handle is not inserted in the product and turn the mode selector to the AUT position. LED "Power" Green: ON
LED Manual/Default: OFF

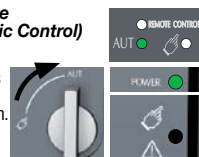

STEP 7B

AUT Mode (Remote Control)

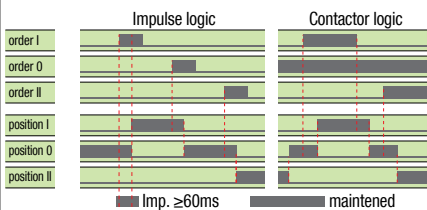

To enable control, close contact 312 with 317. For contactor logic bridge contact 316 with 317. To operate: close the contact corresponding to the desired position. To force the product to 0 position "OFF" bridge contact 313 with 317.

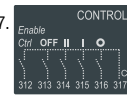

STEP 7C

Manual Mode

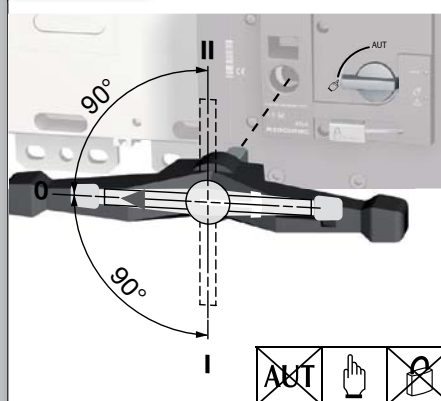

STEP 7D

Padlocking Mode (as standard: in position 0)



5. GENERAL OVERVIEW

5.1. Product introduction

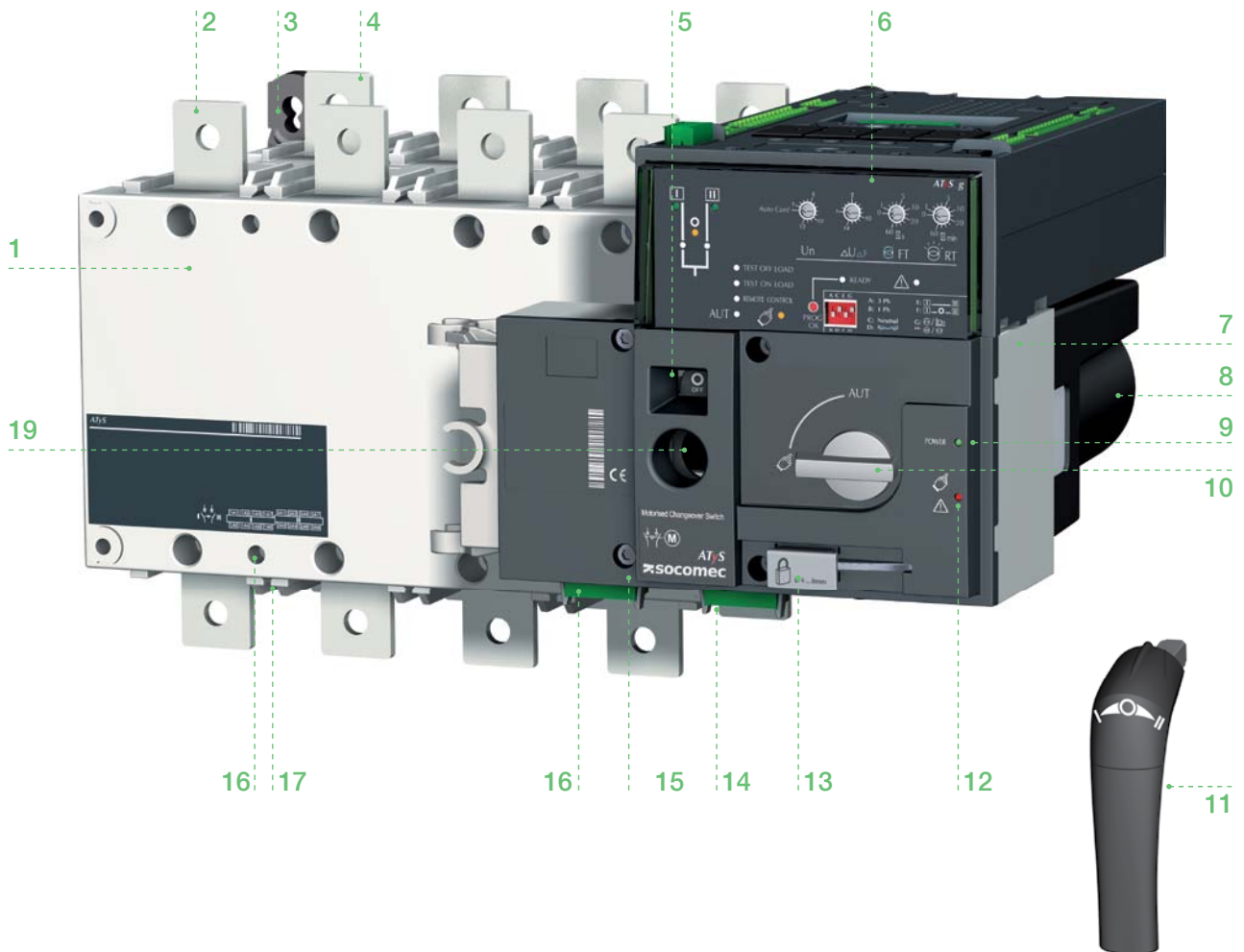

1. Power Section: Changeover switch assembly with inherent mechanical interlock
2. Front: Switch number 1 terminals (3 or 4 pole)
3. Back-plate mounting ATyS fixing lugs
4. Back: Switch number 2 terminals (3 or 4 pole)
5. Switch position indication window: I (On) – O (Off) – II (On)
6. ATS control module with integrated dual power supply
7. Motorized Control Unit
8. Motor housing
9. Green LED Indication: Power
10. Auto / Manual mode selector switch
11. Emergency manual operation “Direct Handle”
12. Red LED Indication: Product Unavailable / Manual Mode / Fault Condition
13. Padlocking facility (Up to 3 padlocks of dia. 4 – 8mm)
14. Output contacts x 4 (Position indication I-O-II and product availability outputs)
15. Facility for locking all controls in the zero position using a RONIS EL11AP Lock
16. Input contacts x 5:
 Position order I-O-II
 Remote control enable
 Override controls and force to Off position
17. Sliders for Terminal Shields
18. Fixing holes for terminal Shields
19. Emergency manual operation shaft location (Accessible only in manual mode)

5.2. Product identification

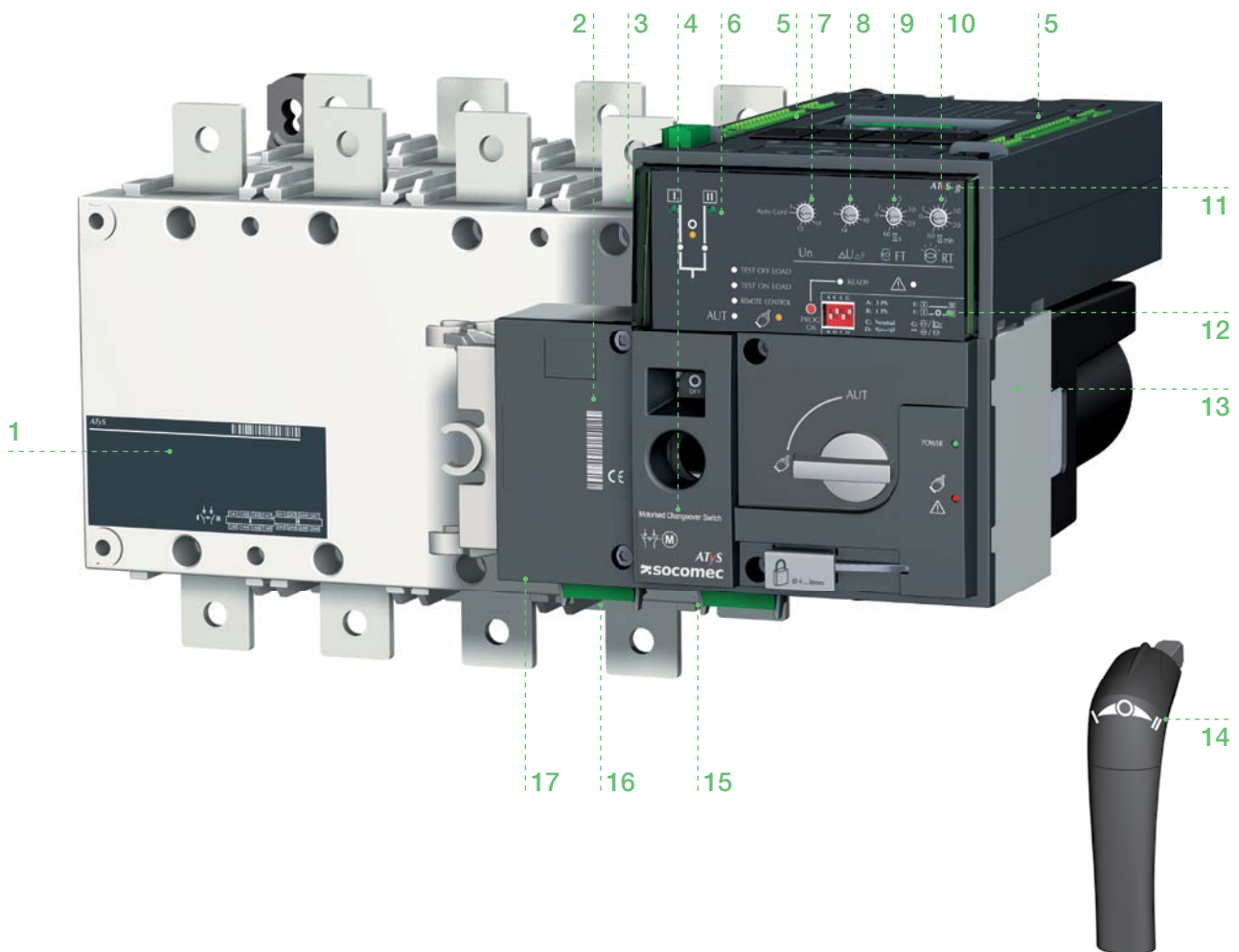

1. Main changeover switch identification label:
Electrical characteristics
Applicable standards and
Terminal incoming and outgoing wiring details.
2. Configuration Guide for network voltage, frequency and thresholds. (Potentiometer 1 & 2)
(Also includes the ATyS g product serial number, barcode & CE marking).
3. Switch 1 (Front) and Switch 2 (back) identification labels
4. ATyS g product current rating and reference number label
5. ATS controller contact identification labels
6. Network status and switch position pictogram with LED's
7. Network voltage and frequency configuration setting potentiometer.
8. Voltage and frequency threshold setting potentiometer.
9. Mains failure time setting potentiometer. (0-60 seconds)
10. Mains return timer setting potentiometer. (0-60 minutes)
11. ATyS product type identification. (ATyS t, ATyS g or ATyS p)
12. Dip switch configuration identification.
13. Motor barcode and serial number
14. Emergency manual operation direction of rotation indication
15. Output contacts identification label.
16. Input contacts identification label.
17. Guide to ATyS g programming steps.

5.3. ATyS control module interface

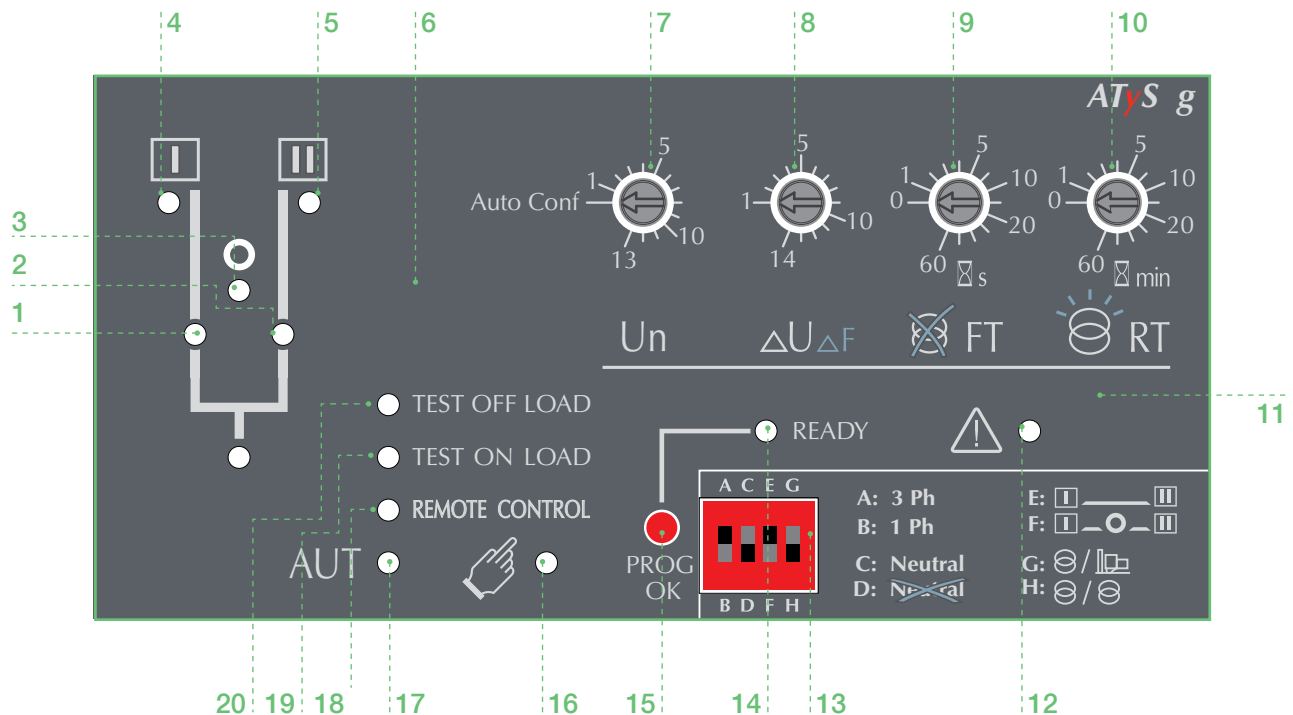

1. Switch 1 LED position indication. (Green when in position I).
2. Switch 2 LED position indication. (Green when in position II).
3. Zero position LED indication. (Yellow when in position 0).
4. Source supply I availability LED indication. (Green when supply I voltage is within the set limits).
5. Source supply II availability LED indication. (Green when supply II voltage is within the set limits).
6. Sealing screw location 1 for use with sealing cover (Available as an accessory)
7. Potentiometer 1 : Network Configuration. (Auto Configuration or refer to the configuration guide sticker on the front of the ATyS g when using the predefined setting positions 1 to 13).
8. Potentiometer 2 : Voltage and Frequency threshold settings. (Refer to the configuration guide sticker on the front of the ATyS g to set the V / Hz threshold. Positions 1 to 14).
9. Potentiometer 3 : Supply FAILURE Time (FT) Adjustable from 0 to 60 seconds.
10. Potentiometer 4 : Supply RETURN Time (RT) Adjustable from 0 to 60 minutes.
11. Sealing screw location 2 for use with the sealing cover.
12. FAULT LED indication.
Red steady light in case of an ATS controller internal fault and blinking in case of an external fault (rotation incorrect / neutral position incorrect).
Switch the product from Auto to Manual and back to Auto to reset a fault condition.
13. Configuration dip switches : (4 dip switches with 2 positions in each A to H).
14. READY LED indication
Green steady light : Product in AUTO, Watchdog OK, Product Available to changeover.
Green flashing : Settings displayed not saved or have been changed since last saved.
(Press PROG OK button in manual mode to save or revert to last saved settings).
15. PROG OK: Configuration save push button. (ATTN: Active in Manual Mode ONLY).
Press briefly to confirm and save all set configuration settings.
Hold pressed for 2 seconds to set the network supply voltage and frequency by Auto Configuration.
This is to be followed by pressing briefly to save the set value configured (see «8.3. Programming», page 52).
16. MANUAL Mode LED indication. (Yellow steady light when in Manual Mode).
17. AUTO Mode LED indication
Green steady light when in Auto mode with no timers running.
Green flashing light when in Auto with timers running in the background.
18. REMOTE CONTROL Mode LED indication.
Yellow steady light when in remote control mode.
Remote control mode is achieved with the Auto/Manu selector switched to Auto and terminals 312 closed with terminal 317. Remote control orders are received through closing 314 to 316 with 317.
19. TEST ON LOAD CONTROL Mode LED indication. (Yellow steady light when in TON mode)
20. TEST OFF LOAD CONTROL Mode LED indication. (Yellow steady light when in TOF mode).

5.4. Environmental

The ATyS g product meets the following environmental requirements:

5.4.1. IP Rating



- IP2X against direct contact for the ATyS g motorization control unit.
- IP2X against direct contact for the power section with the connections in place and when including suitable, correctly installed incoming and outgoing terminal shields.
- IP 0 for the bare power section without terminal shields in place.

5.4.2. Operating Conditions

5.4.2.1. Temperature



- From -20 to +40°C without derating
- From -20 to +70°C when applying a Kt derating correction factor

Kt: Correction Factor	Temperature
0.9	40 °C to 50 °C
0.8	50 °C to 60 °C
0.7	60 °C to 70 °C

* Simplified derating method: $I_{thu} \leq I_{th} \times K_f$

* A more precise calculation may be done for specific applications. Should this be required please contact SOCOMEC.

5.4.2.2. Hygrometry



- 80% humidity without condensation at 55°C
- 95% humidity without condensation at 40°C

5.4.2.3. Altitude



- Up to 2000m in altitude without derating
- For higher altitude the Ka correction factors below apply

Ka: Correction Factor	2000 m < A ≤ 3000 m	3000 m < A ≤ 4000 m
Ue	0.95	0.8
Ie	0.85	0.85

5.4.3. Storage Conditions



5.4.3.1. Temperature



- From -40 to +70°C

5.4.3.2. Storage duration period

- Maximum storage up to a period of 12 months
- (Recommendation: To be stored in dry, non corrosive and non saline atmospheric conditions)

5.4.3.3. Storage position

- ≤ 630 A: a maximum of 3 boxes may be stocked vertically
- ≥ 800 A: a maximum of 1 box may be stocked vertically

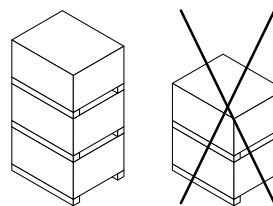

5.4.4. Volume and shipping weights by reference ATyS g

Frame Size	Rating	N° of Poles	Reference Number	Weight (kg)		Volume (cm) inc Packing
				Net	Gross	
B3	125A	3	95 53 3 012	6,8	10,1	360x480x370
		4	95 53 4 012	8,0	11,3	360x480x370
	160A	3	95 53 3 016	6,8	10,1	360x480x370
		4	95 53 4 016	8,0	11,3	360x480x370
	200A	3	95 53 3 020	6,8	10,1	360x480x370
		4	95 53 4 020	8,0	11,3	360x480x370
B4	250A	3	95 53 3 025	7,7	11,0	360x480x370
		4	95 53 4 025	8,5	11,8	360x480x370
	315A	3	95 53 3 031	7,8	11,1	360x480x370
		4	95 53 4 031	8,9	12,2	360x480x370
	400A	3	95 53 3 040	7,8	11,1	360x480x370
		4	95 53 4 040	8,9	12,2	360x480x370
B5	500A	3	95 53 3 050	12,5	15,8	536x378x427
		4	95 53 4 050	14,4	17,7	536x378x427
	630A	3	95 53 3 063	13,0	16,3	536x378x427
		4	95 53 4 063	15,1	18,4	536x378x427
B6	800A	3	95 53 3 080	29,0	45,0	730x800x600
		4	95 53 4 080	33,3	49,3	730x800x600
	1000A	3	95 53 3 100	29,5	45,5	730x800x600
		4	95 53 4 100	34,0	50,0	730x800x600
	1250A	3	95 53 3 120	30,0	46,0	730x800x600
		4	95 53 4 120	34,7	50,7	730x800x600
B7	1600A	3	95 53 3 160	34,2	50,2	730x800x600
		4	95 53 4 160	40,5	56,5	730x800x600
B8	2000A	3	95 53 3 200	51,8	67,8	730x800x600
		4	95 53 4 200	62,7	78,7	730x800x600
	2500A	3	95 53 3 250	51,8	67,8	730x800x600
		4	95 53 4 250	62,7	78,7	730x800x600
	3200A	3	95 53 3 320	62,1	78,1	730x800x600
		4	95 53 4 320	76,4	92,4	730x800x600

5.4.5. CE marking

The ATyS g complies with the European directive for:

- The Electromagnetic compatibility no. 2004/108/CE dated 15th of December 2004.
- Low voltage directive no. 2006/95/CE dated 12th of December 2006.



5.4.6. Lead free process

- The ATyS g complies with the European directive for RoHS.



5.4.7. WEEE

The ATyS g is built in accordance with 2002/96/CE directive:

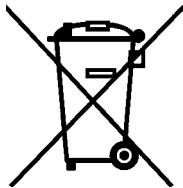

5.4.8. EMC standard

The ATyS g is designed and built in accordance with IEC 60947-1 standards (Products intended to be installed in an «Industrial, Commercial and/or Residential Environment» therefore respecting both Class A as well as Class B EMC requirements).

Description	Std (IEC)	Requirement (criteria)
Conducted	CISPR 11	Class B
Radiated	CISPR 11	Class B
ESD contact	61000-4-2	4KV (B)
ESD air	61000-4-2	8KV (B)
Electromagnetic field	61000-4-3	10V/m (A)
RF Conducted	61000-4-6	10V (A)
Burst	61000-4-4	2KV (B) power 1KV (B) control
Surge Common	61000-4-5	2KV (B)
Surge differential	61000-4-5	1KV (B)

5.5. ATyS g ACCESSORIES AVAILABLE

BRIDGING BARS

To connect switch I & II load terminals together.

TERMINAL SHROUDS (125 TO 630 A)

Incoming and outgoing protection against direct contact with the connection terminals or parts. Cannot be mounted in the rear position at the same time as the voltage sensing and power outlet kit or the bridging bars.

Can be mounted top or bottom, in front or in rear position.

TERMINAL SCREENS

Incoming and outgoing protection against direct contact with the connection terminals or parts.

DOOR ESCUTCHEON PLATE

An accessory to be fixed onto a cabinet door to frame the controller part of flush mounted ATyS g transfer switches.

DC POWER SUPPLY (DC -> AC)

Allows a standard 230Vac ATyS d to be supplied through a 12/24/48Vdc Aux Power supply.

SUPPLEMENTARY AUXILIARY CONTACT (AC)

Pre-breaking and signaling of positions I and II: 1 additional auxiliary contact NO / NC auxiliary contact in each position. Included as standard for ratings from 2000 to 3200A. For Low level AC: please consult SOCOMEC.

KEY LOCK AUTO / MANUAL SELECTOR SWITCH

The ATyS g mode selector switch is delivered with a rotary handle as standard. This can be replaced with a key lock.

RONIS KEY PADLOCKING ACCESSORIES

Locking of the electrical and manual operation by means of a RONIS EL11AP lock. Possibility of locking in all positions, if the "Padlocking in the 3 positions" option is ordered.

Not compatible with flush mounting.

PADLOCKING IN 3 POSITIONS

Allows locking of the operation in the 3 positions I, 0 and II. (Factory fitted accessory)

CONTROL VOLTAGE TRANSFORMER

Allows a standard 230 V AC device to be supplied with 400 VAC.

MOUNTING SPACERS (125 TO 630 A)

Raises the device's terminals 10 mm away from the backplate or frame

REMOTE INTERFACES D10

Remote Display: Allows source supply state and switch positions to be displayed remotely. (LED display)

Typically door mounted or $\leq 3m$ away from the ATyS.

COMMUNICATION CABLE

RJ 45 communication cable (3m long) for use with the D10 remote display/controller or Ethernet modules.

Others:

Refer to the end of this instruction manual or the latest SOCOMEC product catalogue. (Downloadable from www.socomec.com)

6.1.2. Dimensions: Frame B6 & B7 (800A to 1600A)

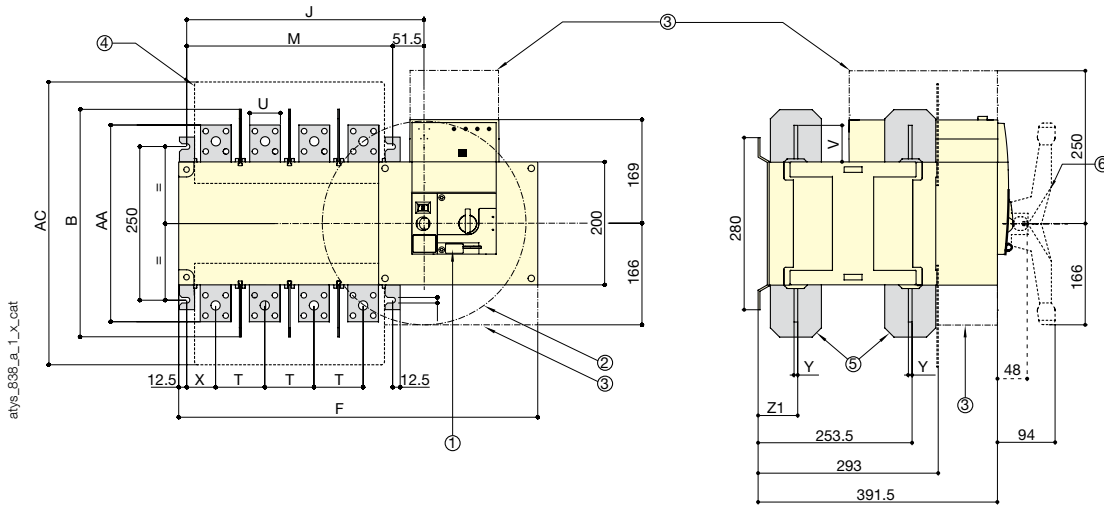

800 to 1000 A

1250 A

1600 A

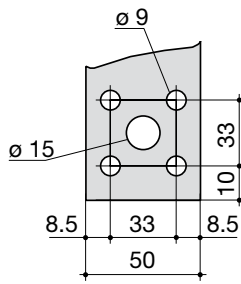

svr_077_a_1_x_cat

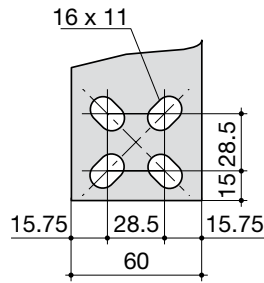

svr_078_b_1_x_cat

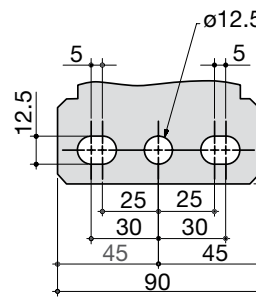

svr_088_a_1_x_cat

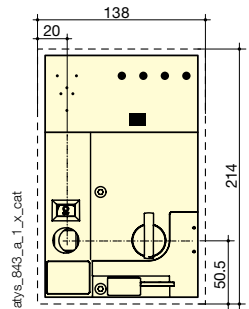

7

1. Padlocking Facility: Locking bracket for up to 3 padlocks of dia. 4 – 8mm
2. Emergency manual operation: Maximum operating radius with an operating angle of 2x 90°
3. Connection and disconnection area
4. Mounting stand off with spacer accessory
5. Phase Barriers
6. Emergency removable handle
7. Flush mounting cutout dimensions for front door



CAUTION

To consider the space required for manual operation and wiring.
(When using the ATyS g emergency handle: note 2).

Rating (A)	Overall dimensions		Terminal screens		Body				Switch mounting			Connection			
	B	AC	F 3p.	F 4p.	J 3p.	J 4p.	M 3p.	M 4p.	T	U	V	X	Y	Z1	AA
800	370	461	504	584	307	387	255	335	80	50	60.5	47.5	7	66.5	321
1000	370	461	504	584	307	387	255	335	80	50	60.5	47.5	7	66.5	321
1250	370	461	504	584	307	387	255	335	80	60	65	47.5	7	66.5	330
1600	380	531	596	716	399	519	347	467	120	90	44	53	8	67.5	288

All dimensions in mm

6.1.3. Dimensions: Frame B8 (2000A to 3200A)

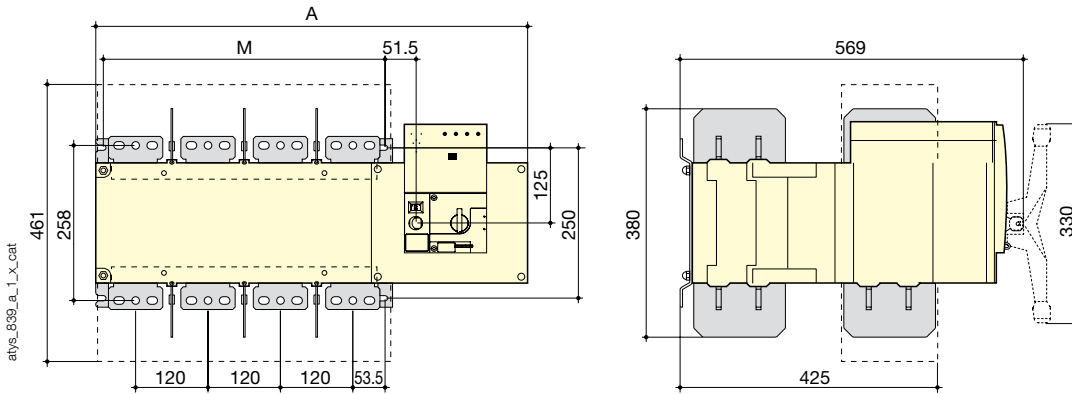

2000 to 3200 A

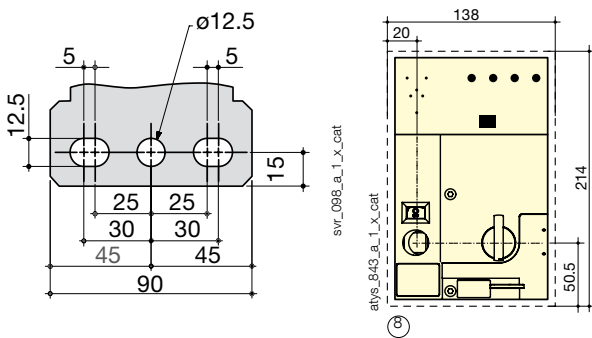

1. Padlocking Facility: Locking bracket for up to 3 padlocks of dia. 4 – 8mm
2. Emergency manual operation: Maximum operating radius with an operating angle of 2x 90°
3. Connection and disconnection area
4. Mounting stand off with spacer accessory
5. Phase Barriers
6. Emergency removable handle
7. Frame B8, (Dual frame) factory fitted power terminal connections
8. Flush mounting cutout dimensions for front door

	CAUTION	To consider the space required for manual operation and wiring. (When using the ATyS g emergency handle: note 2).
---	---------	--

Rating (A)	Overall dimensions		Switch mounting	
	A 3p.	A 4p.	M 3p.	M 4p.
2000 ... 3200	596	716	347	467

All dimensions in mm

6.2. Mounting orientation

125A to 630A	Recommended	OK	Not Allowed	OK
800A to 3200A	Recommended	Not Allowed	OK	OK



CAUTION

Always install the product on a flat and rigid surface.

6.3. Assembly of customer mounted accessories



DANGER

Never handle any customer mounted accessories while there may be the risk of voltage being or becoming present.

6.3.1. Bridging bar installation

125A to 630A

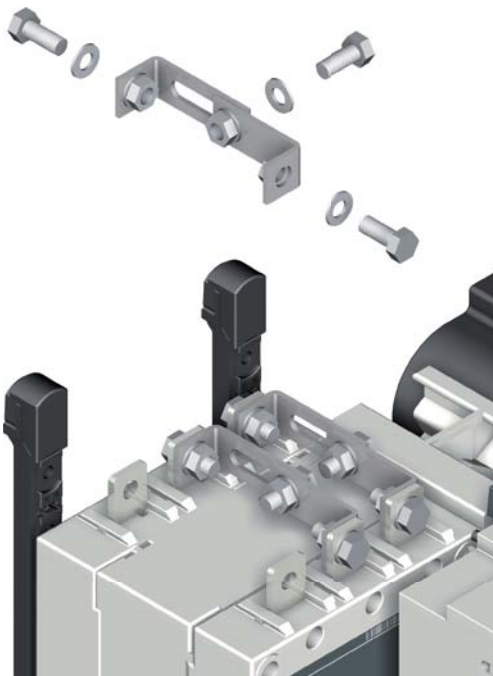

800A to 1600A

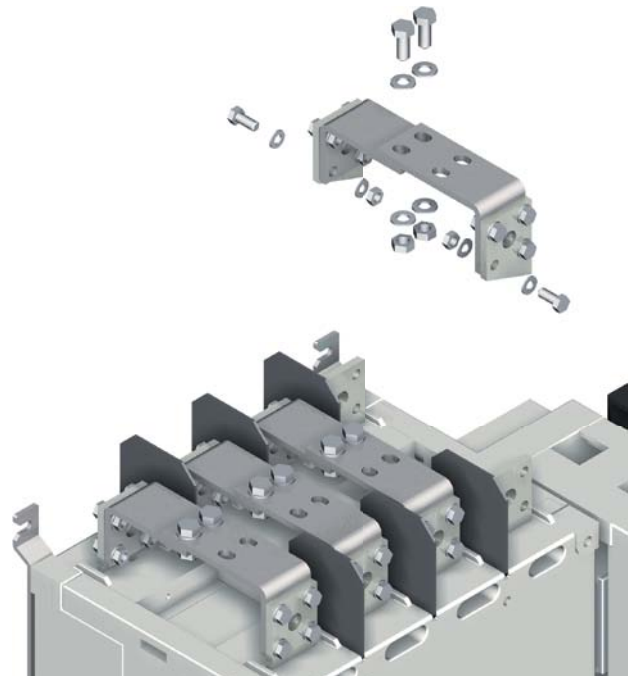

It is possible to mount the bridging bars on either side of the switch

Recommended tightening torque:

M6: 4,5 N.m
M8: 8,3 N.m
M10: 20 N.m
M12: 40 N.m

Maximum tightening torque:

M6: 5,4 N.m
M8: 13 N.m
M10: 26 N.m
M12: 45 N.m

6.3.2. Terminal shrouds

Available from 125A to 630A
Frame B3 to Frame B5:

- Upstream, downstream, front or rear mounting.
- When fitted with bridging bars only the front terminal shrouds are to be installed.

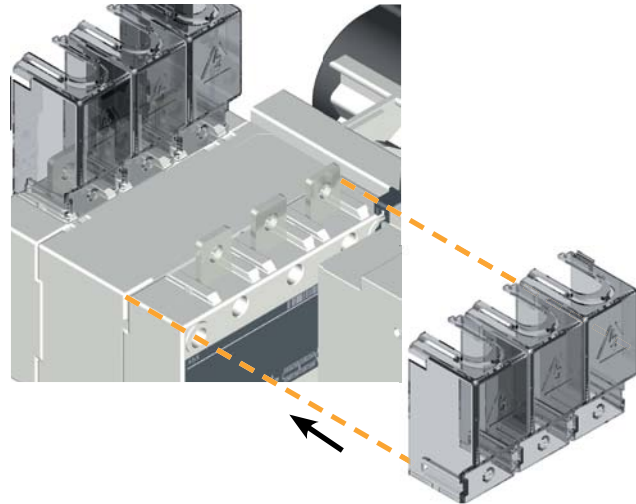

6.3.3. Terminal screens

125A to 630A

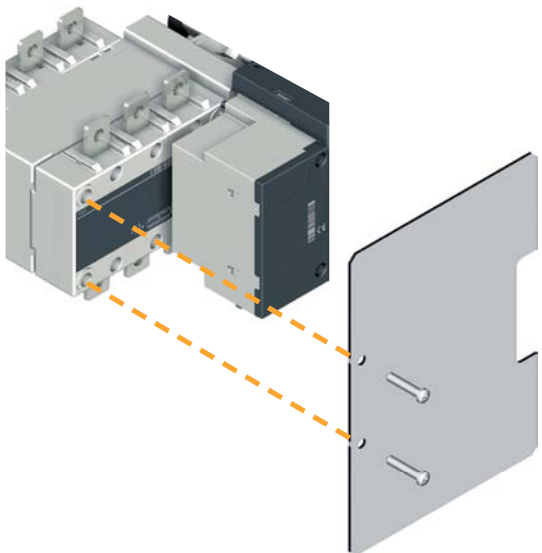

500A to 1600A

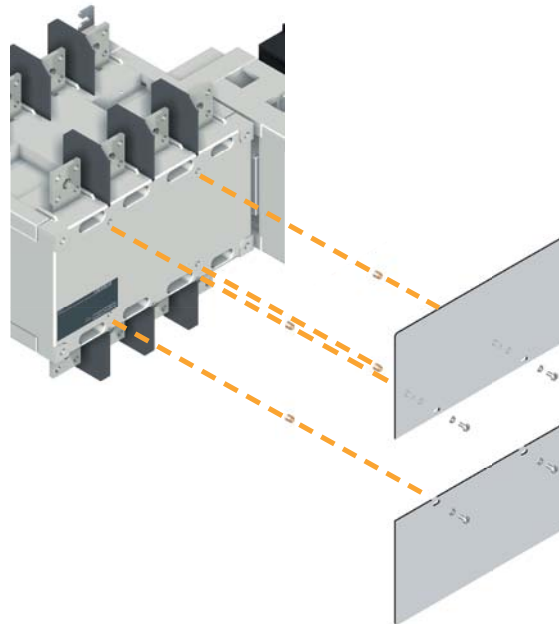

2000A to 3200A

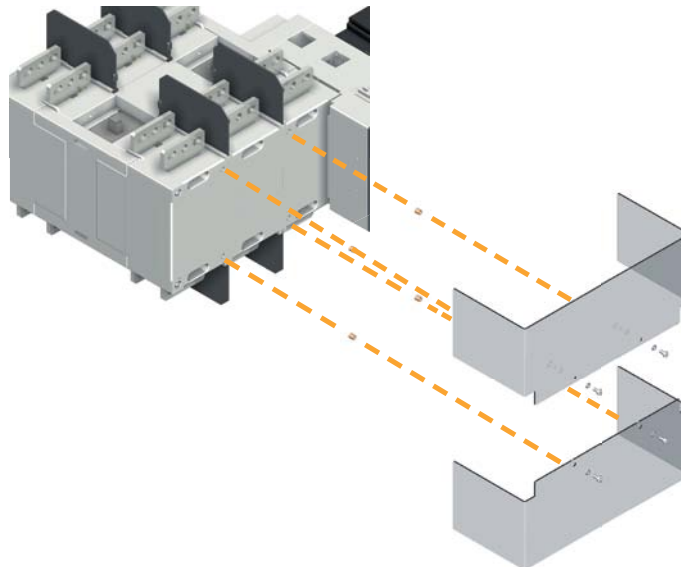

6.3.4. Copper bar connection kits (2000A to 3200A : Frame B8)

 Conditions of use of these products may lead to a derating.

 [SOCOME C "Application guide"](#)

 www.socomec.com

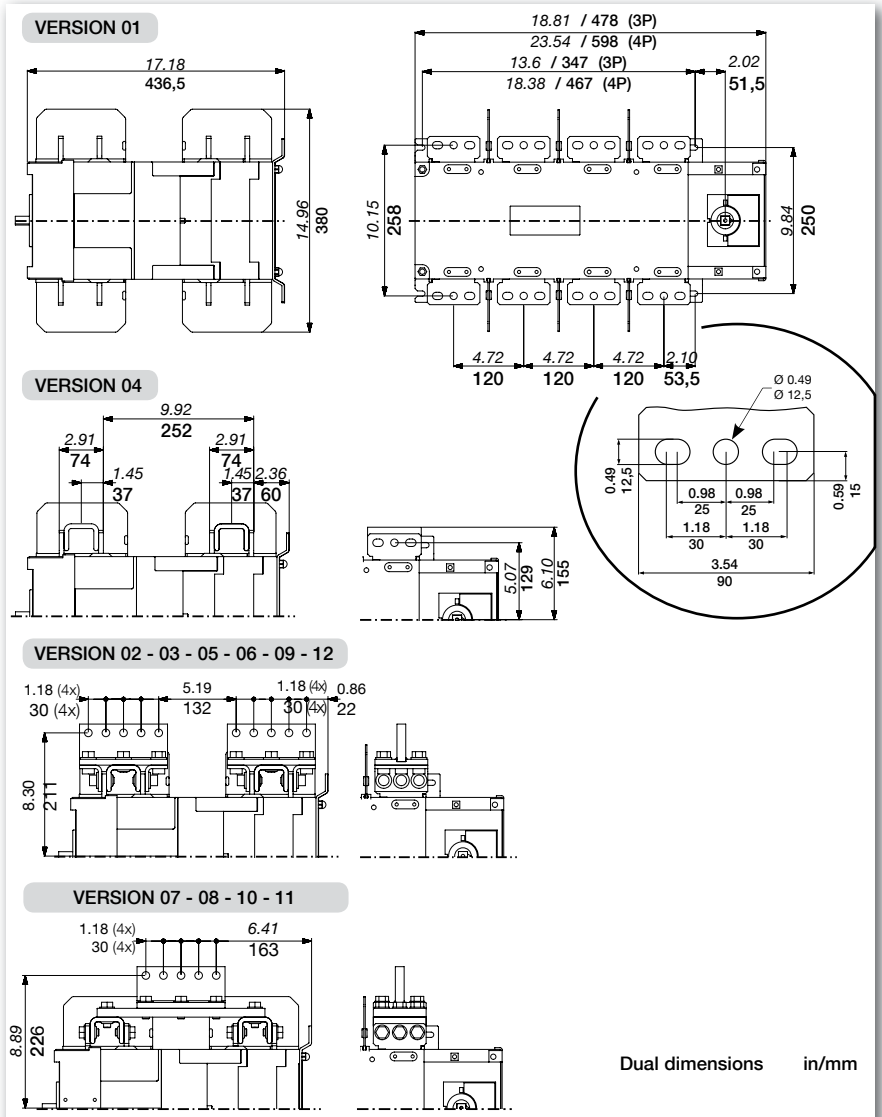
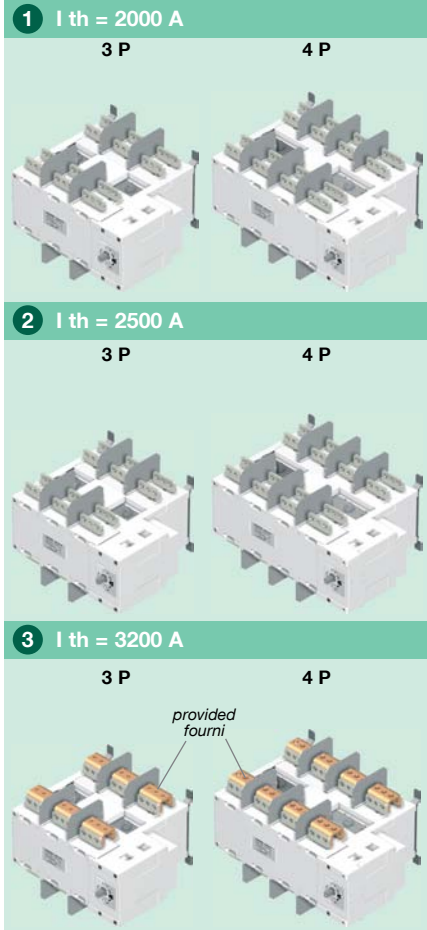













Dual dimensions in/mm

Data for Bolts, Nuts and Washers for Busbar Connections.

 TO BE SUPPLIED BY OTHERS

Connection reference numbers and contents:

 x 1 <i>included with 3200A product as standard</i> 2619 1200	 x 6 708 lb-in 80 Nm 2699 1200 2699 1201	 x 1 +  x 6 708 lb-in 80 Nm 2629 1200
 x 2 +  x 6 708 lb-in 80 Nm 2639 1200	 x 1 +  x 6 708 lb-in 80 Nm 4109 0250	 x 1 +  x 6 708 lb-in 80 Nm 4109 0320

VERSION	 708 lb-in 80 Nm	 Rondelle contact MOY. M M12 NFE 25 511	 H M12
01	H M12-35 6.8 - 6 x	12 x	6 x
02	H M12-55 6.8 - 3 x	6 x	3 x
03	H M12-55 6.8 - 5 x	10 x	5 x
04	A H M12-35 6.8 - 3 x	3 x	-
	B H M12-45 6.8 - 3 x	3 x	-
05	H M12-65 6.8 - 3 x	6 x	3 x
06	H M12-65 6.8 - 5 x	10 x	5 x
07	H M12-55 6.8 - 3 x	6 x	3 x
08	H M12-55 6.8 - 5 x	10 x	5 x
09	H M12-55 6.8 - 10 x	20 x	10 x
10	H M12-65 6.8 - 3 x	6 x	3 x
11	H M12-65 6.8 - 5 x	10 x	5 x
12	H M12-65 6.8 - 10 x	20 x	10 x

Note: Reference numbers and quantity given above and below are for one connection and per pole. For a full set multiply the quantity indicated by the number of poles (3 or 4 pole) and then multiply by 2 (N° of switches)

6.3.5. Incoming copper bar connection kit assembly

2000A – 2500A (Minimum Cu bar section for Ith 2000A 3x100x5mm; and for Ith 2500A 4x100x5mm)

VERSION 01

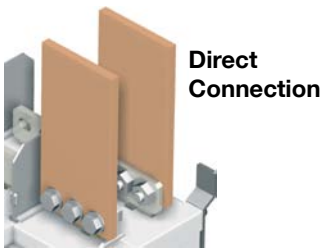

VERSION 02

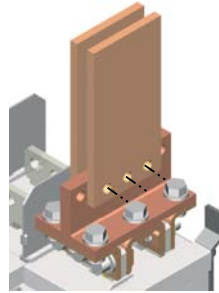

VERSION 03

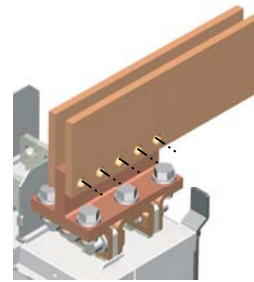

V2 & V3

Kit :
2619 1200 x 1
2629 1200 x 1
2639 1200 x 1

3200A (Minimum Cu bar section 3x100x10mm)

VERSION 04

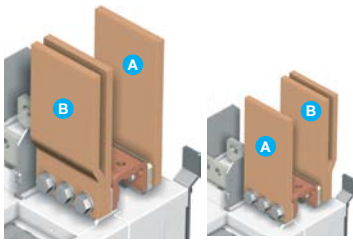

VERSION 05

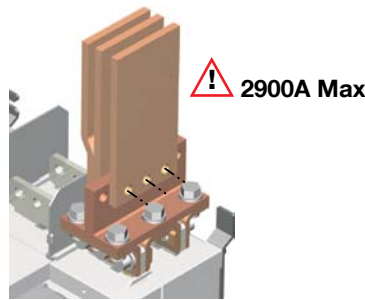

VERSION 06

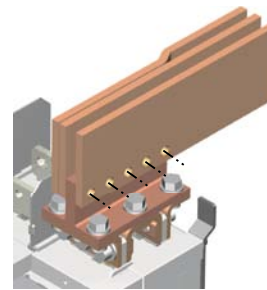

Connection bar 2619 1200 included with 3200A

V4

Kit :
2699 1200 x 1

V5 & V6

Kit :
2629 1200 x 1
2639 1200 x 1

6.3.6. Outgoing bridge connection assembly

2000A – 2500A (Minimum Cu bar section for Ith 2000A 3x100x5mm; for Ith 2500A 4x100x5mm)

VERSION 07

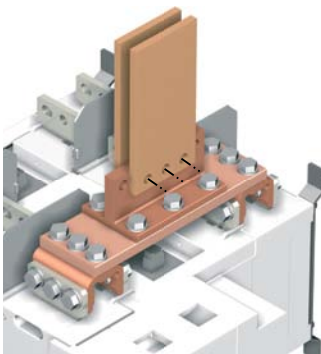

VERSION 08

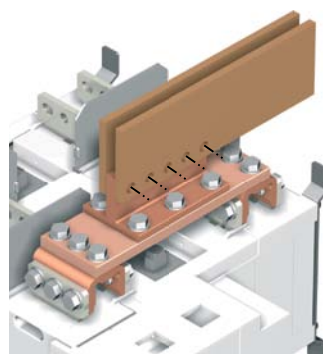

VERSION 09

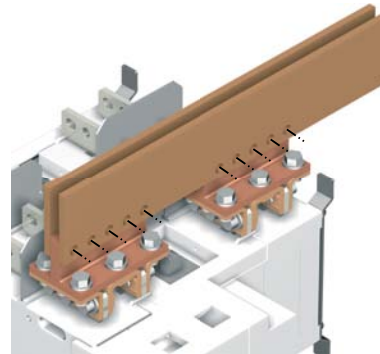

V7 & V8

Kit :
2619 1200 x 2
2699 1201 x 2
2629 1200 x 1
4109 0320 x 1

V9

Kit :
2619 1200 x 2
2629 1200 x 2
2639 1200 x 2

3200A (Minimum Cu bar section 3x100x10mm)

VERSION 10

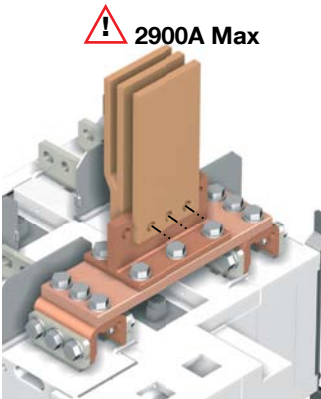

VERSION 11

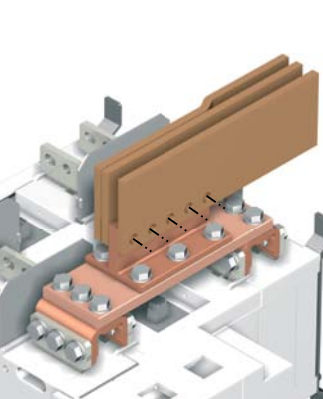

VERSION 12

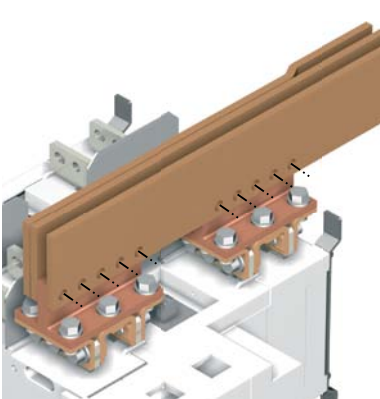

Connection bar 2619 1200 included with 3200A

V10 & V11

Kit :
2699 1201 x 2
2629 1200 x 1
4109 0320 x 1

V12

Kit :
2629 1200 x 2
2639 1200 x 2

6.3.7. Power supply

Power Transformer intended for 400VAC, Phase to Phase voltage applications that do not provide the availability of a neutral conductor. Transformer data: 400VAC – 230VAC: 200VA. In this case the ATyS g will require 2 transformers to be connected as shown below.

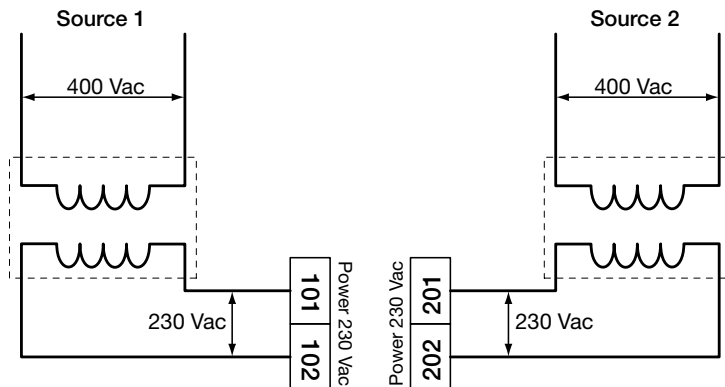

6.3.8. Raised mounting spacers

Available for 125A to 630A ratings only
Frames B3, B4 and B5

1 set including 2 spacers raises the device's terminals 10mm away from the bottom of the enclosure or frame on which the device is mounted. These may also be used to replace the original mounting spacers.



6.3.9. Padlocking key interlocks

Intended for locking the electrical control and the backup control in position 0 using a RONIS EL11AP lock. As standard, key locking is in the 0 position.

Optionally and when including the option “padlocking in 3 positions” key locking will be in positions I, 0 or II

125A to 630A

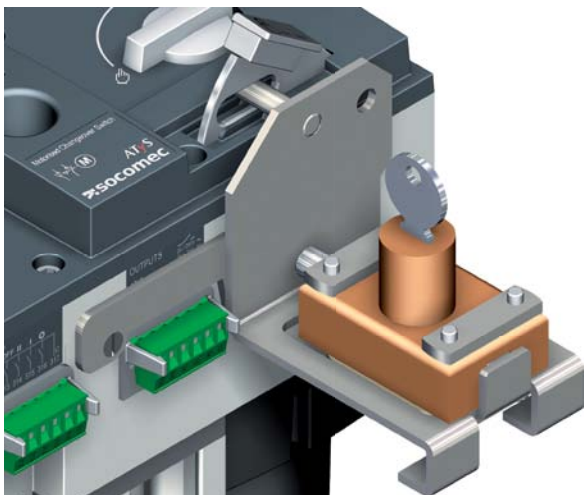

800A to 3200A

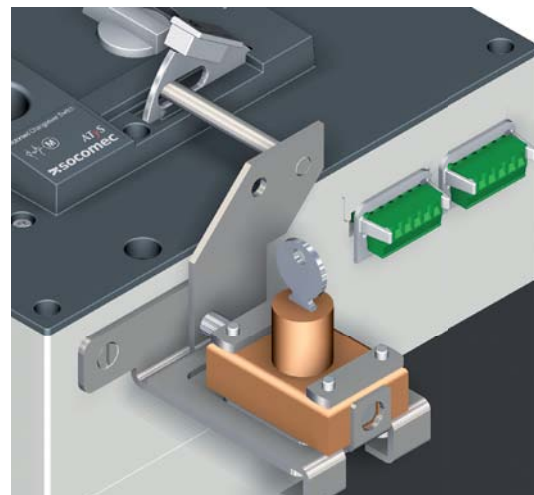

6.3.10. Additional auxiliary contacts

Intended for pre breaking and signaling of positions I and II:

A maximum of 2 NO/NC additional auxiliary contacts can be fitted for each position. (Customer assembly may be required.)

125A to 630A (Optional)

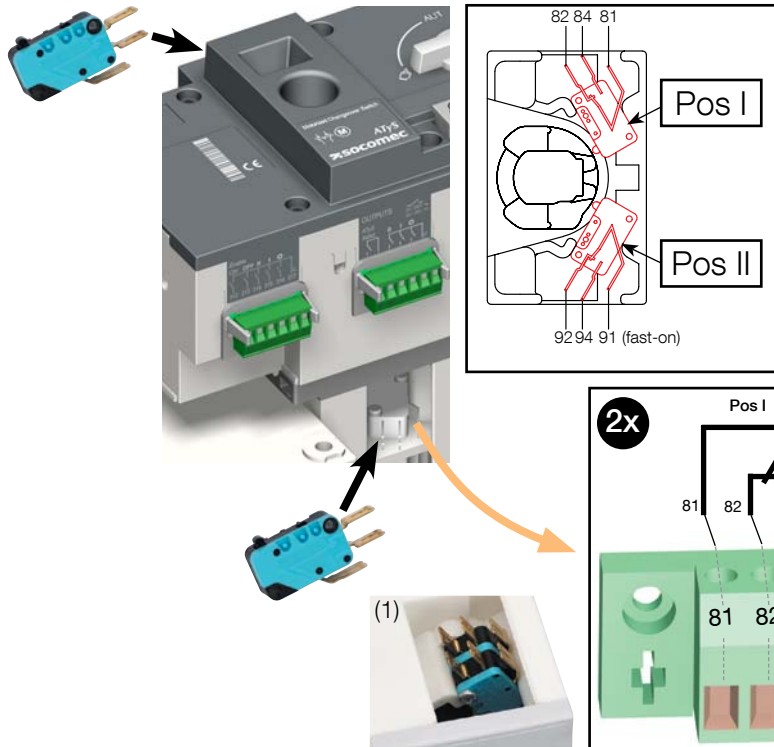

800A to 1600A (Optional) 2000A to 3200A (Standard)

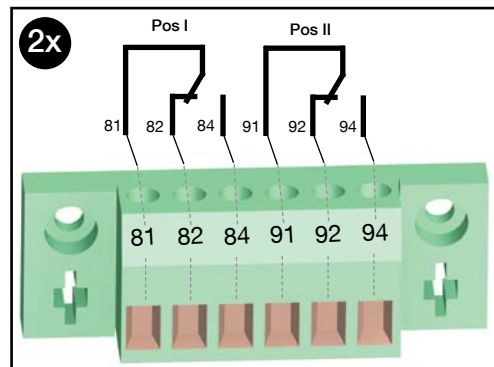

⁽¹⁾ When mounting one auxiliary contact on position I or II, use the short screws provided. When mounting two auxiliary contacts on position I or II, use the long screws provided.

7. CONNECTIONS

7.1. Power circuits

For specific networks and power connection diagram possibilities, please refer to page 36.

7.1.1. Cable or bar connections

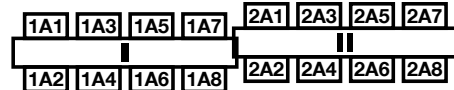
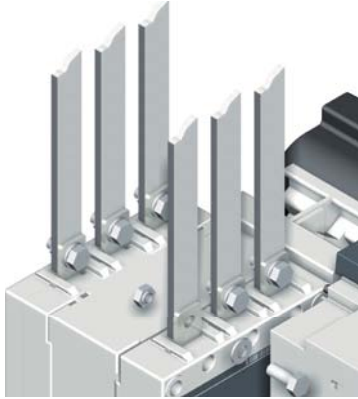

<p>Recommended tightening torque:</p> <ul style="list-style-type: none"> • M6: 4,5 N.m • M8: 8,3 N.m • M10: 20 N.m • M12: 40 N.m 	<p>Maximum tightening torque:</p> <ul style="list-style-type: none"> • M6: 5,4 N.m • M8: 13 N.m • M10: 26 N.m • M12: 45 N.m
--	---

7.1.2. Power connection terminals

125A to 630A - Refer to section "Product dimensions", page 25 for power connection terminal details.

800A to 1000A

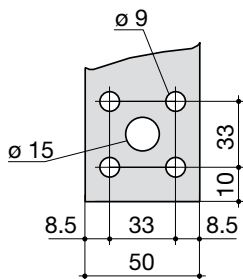

svr_077_a_1_x_cat

1250A

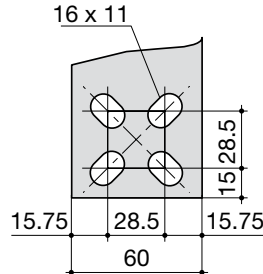

1600A to 3200A

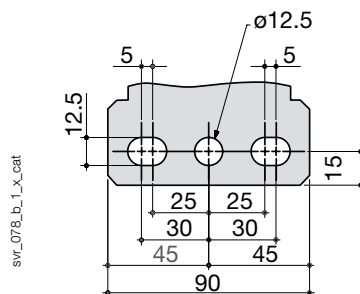

svr_078_b_1_x_cat

7.1.3. Power connection cross-section

	B3			B4			B5		B6			B7	B8		
	125A	160A	200A	250A	315A	400A	500A	630A	800A	1000A	1250A	1600A	2000A	2500A	3200A
Minimum cable section Cu according to IEC 60947-1 (mm ²)	35	35	50	95	120	185	2x95	2x120	2x185	-	-	-	-	-	-
Recommended cable section Cu (mm ²), lth	-	-	-	-	-	-	2x32 x5	2x40 x5	2x50 x5	2x63 x5	2x60 x7	2x100 x5	3x100 x5	2x100 x10	3x100 x10
Maximum cables section Cu (mm ²)	50	95	120	150	240	240	2x185	2x300	2x300	4x185	4x185	6x185	-	-	-
Maximum bars width Cu (mm)	25	25	25	32	32	32	50	50	63	63	63	100	100	100	100

Note for all ratings: Take into account the connection cable lengths and/or others environmental specific operating conditions.

7.1.4. Connection

The product is delivered with the following configuration.

- Connectors 101 to 106, I 1/2 to I 7/8, located on the right side of the controller are associated with switch I
- Connectors 201 to 206, II 1/2 to II 7/8, located on the left side of the controller are associated with switch II.

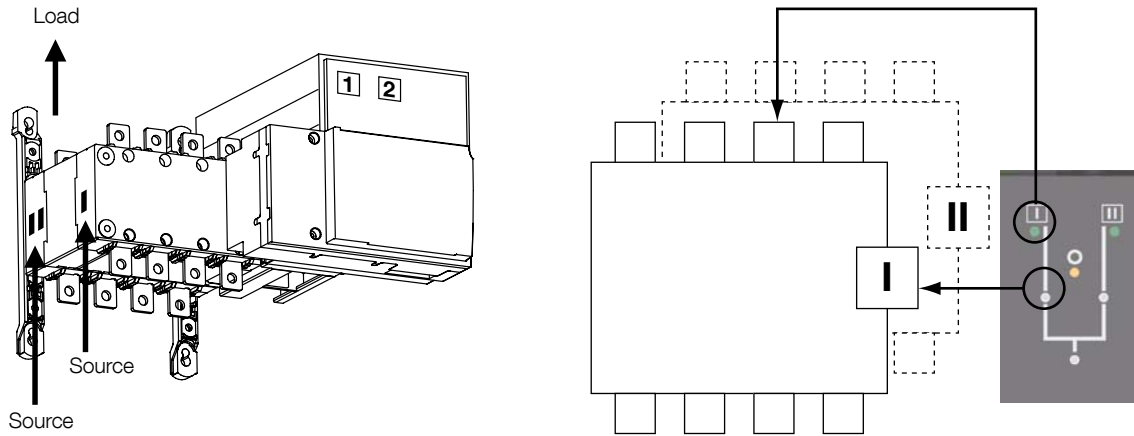

CAUTION

The ATyS MUST be connected with the «main supply Switch I» and the «Genset supply on Switch II». It is NOT possible to connect the priority (main) supply to Switch II.
(Should you require the priority supply on Switch II order an ATyS that is programmable).

Aux Supply-2
Power-230V
208-277 Vac $\pm 20\%$
(166-332Vac)

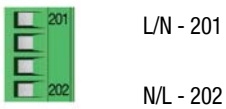

Power 208-277V $\pm 20\%$

Aux Supply-1
Power-230V
208-277 Vac $\pm 20\%$
(166-332Vac)

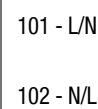

Power 208-277V $\pm 20\%$

Voltage Sensing
Source II - 1Ph / 3Ph
0 - 332 / 575

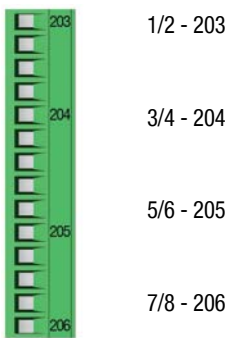

II 1/2
Voltage sensing switch II
II 3/4
II 5/6
II 7/8

Voltage Sensing
Source I - 1Ph / 3Ph
0 - 332 / 575

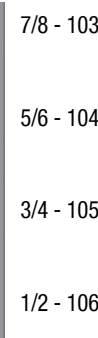

I 7/8
Voltage sensing switch I
I 5/6
I 3/4
I 1/2



CAUTION

It is recommended to connect power and sensing with the ATyS voltage sensing and power supply kit available as an accessory.
In this case ensure to mount the kit before connecting the power cables.

7.2. Networks and Power Connection possibilities

7.2.1. Type of networks

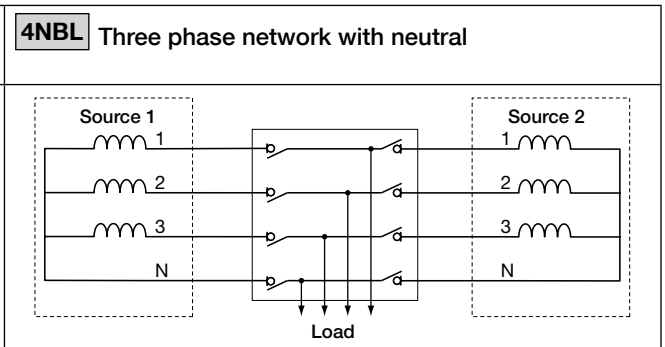
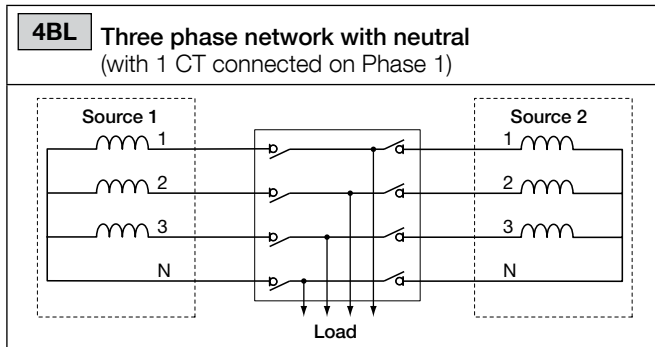
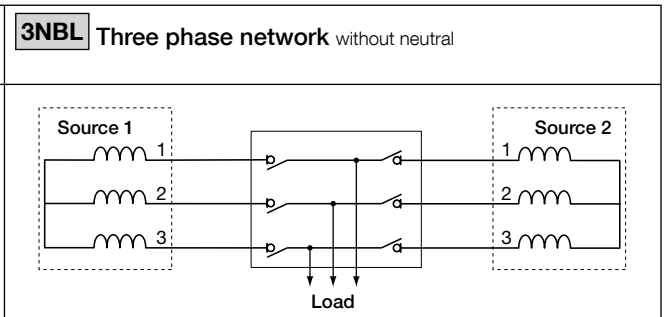
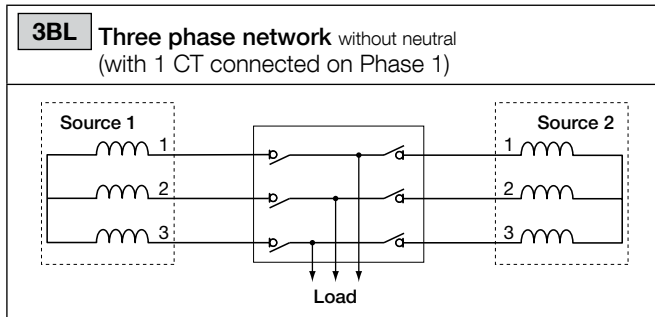
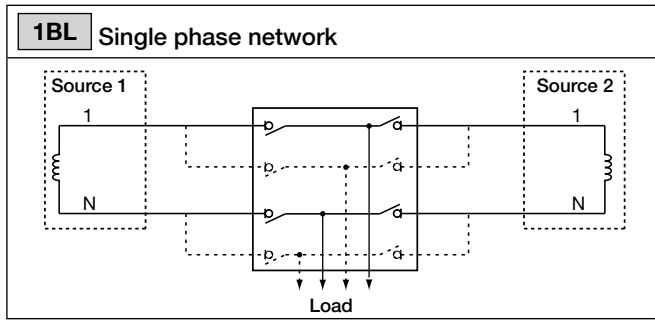

7.2.2. Metering and sensing details

Network type					
	1BL	3BL	3NBL	4BL	4NBL
Source [1]	1 phase 2 wire	3 phase 3 wire	3 phase 3 wire	3 phase 4 wire	3 phase 4 wire
Source [2]					
Source [1]					
Source [2]					
ATyS p CT cabling (load side)					
Voltage sensing					
Source [1]	- V1	U12, U23, U31	U12, U23, U31	U12, U23, U31 V1, V2, V3	U12, U23, U31 V1, V2, V3
Source [2]	- V1	U12, U23, U31 -	U12, U23, U31 -	U12, U23, U31 V1, V2, V3	U12, U23, U31 V1, V2, V3
Source presence (source available)	✓	✓	✓	✓	✓
Source in ranges (U, V, F)	✓	✓	✓	✓	✓
Rotation phase order	-	✓	✓	✓	✓
Neutral position	-	-	-	✓	✓
Voltage unbalanced is lower than threshold	-	✓	✓	✓	✓

7.3. Control circuits

7.3.1. Typical ATyS g wiring

Example: Control wiring for a 400VAC application having a 3 phase and neutral supply.

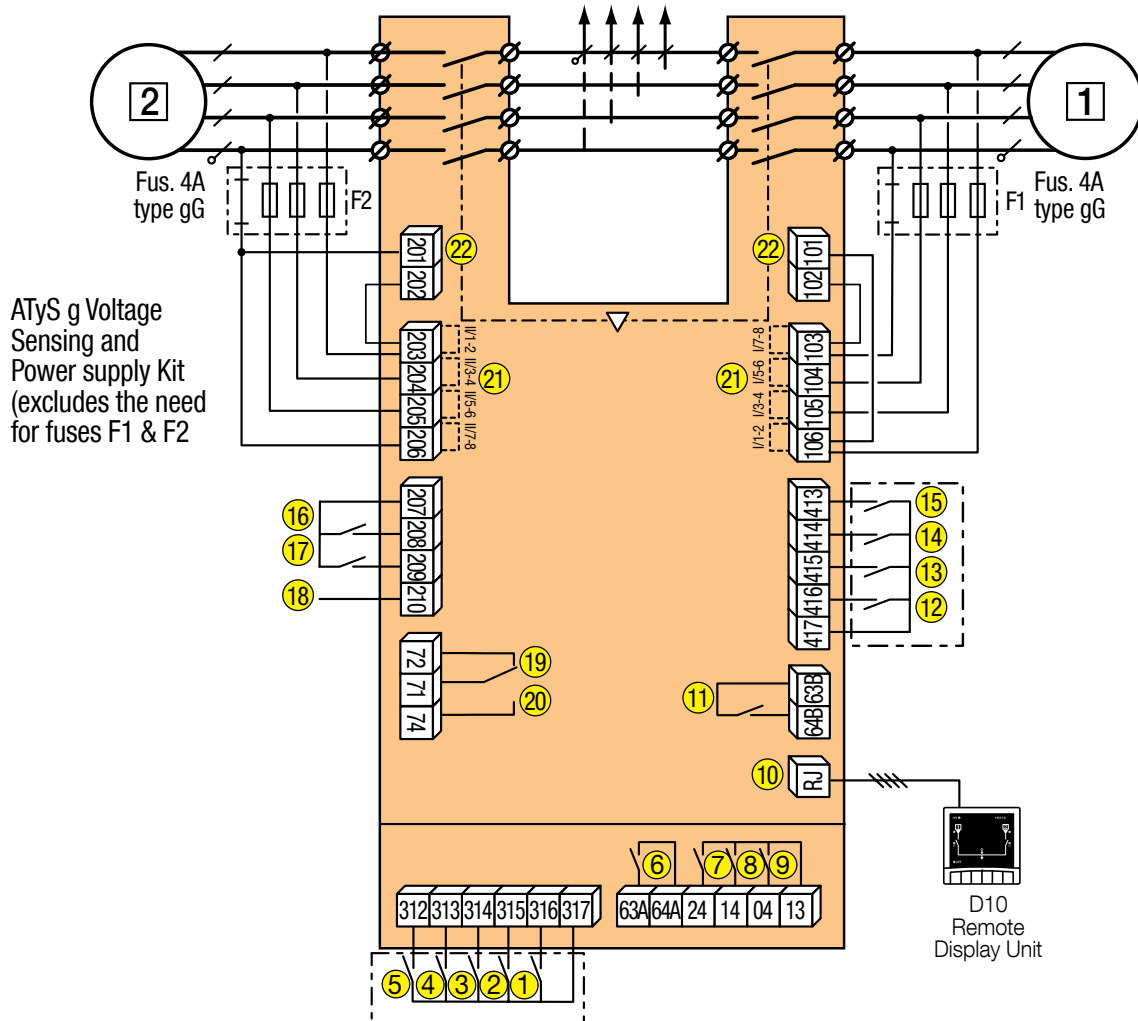

- 1 preferred source
- 2 alternate source

- 1. Position 0 order
- 2. Position I order
- 3. Position II order
- 4. Zero position priority order
- 5. Remote Control Enable (Priority over Auto)
- 6. Product Available output (Motor)
- 7. Position II aux contact
- 8. Position I aux contact

- 9. Position 0 aux contact
- 10. O/P to D10 remote display
- 11. Product Available output (ATS)
- 12. I/P Inhibition of the ATS controls
- 13. I/P Manual retransfer
- 14. S2 Stability Time Bypass: 2AT
- 15. M-G: Priority to TON / M-M: Priority enable/disable
- 16. TEST OFF LOAD Signal : TOF
- 17. M-G: Test On Load Input (TON) / M-M: Priority source selection

- 18. Not used
- 19-20. Genset starting and stopping order

Control	71/72 (19)	71/74 (20)
Generator starting	Contact closed	Contact open
Generator stop-ping	Contact open	Contact closed

- 21. Voltage sensing inputs
- 22. Power supply inputs



CAUTION

Verify that the Auxiliary power supply feeding terminals 101 and 102 / (201 and 202) are within the limits of 208VAC -> 277VAC ±20%



DANGER

Do not handle any control or power cables connected to the ATyS when voltage may be present.

7.3.2. ATyS g input and output contacts

7.3.2.1. Motorisation module wiring



 All pressure on the connector pins is to be avoided during wiring of the auxiliary cables

CONTROL		OUTPUTS	
Enable	312	Prod Avail Common	63A
Ctrl OFF II I O	313	Prod Avail O/P:	64A
Sw to Pos II I/P:	314	Pos II Aux Contact:	24
Sw to Pos I I/P:	315	Pos I Aux Contact:	14
Sw to Pos 0 I/P:	316	Pos 0 Aux Contact:	04
Common:	317	Common:	13

7.3.2.2. ATS control module wiring



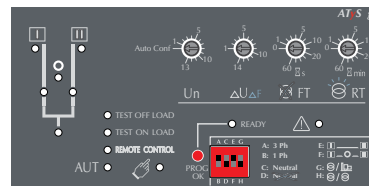











Aux Supply-1 Power 230V 208-277 VAC $\pm 20\%$ (166-332V _{ac}) 101- L/N 102- N/L (166-332V _{ac})	Voltage Sensing Source 1 - 1Pw/3Ph 0-332 / 575 7/8 - 103 5/6 - 104 3/4 - 105 1/2 - 106	ATS Module Control Inputs (Fixed) Common 413 414 415 416 417	Product available RJ45 CAUTION The RJ45 terminal is not a LAN connection
Aux Supply-2 Power 230V 208-277 VAC $\pm 20\%$ (166-332V _{ac}) L/N - 201 N/L - 202	Voltage Sensing Source 2 - 1Pw/3Ph 0-332 / 575 1/2 - 203 3/4 - 204 5/6 - 205 7/8 - 206	Common - Prog Inputs Not used 207 208 209 210	Genset Start Signal 72 71 74



7.3.2.3. Terminal denomination, description and characteristics.

Denomination	Terminal	Description	Characteristics	Recommended Cable Section
Motorisation Module Output Contacts	04	Aux Contact Position 0 - Normally Open Contact	Dry Contacts 2A AC1 / 250V 2A / 24Vdc	1.5 – 2.5 mm ²
	13	Common for Aux Contacts positions I - 0 - II		
	14	Aux Contact position I: Normally Open Contact		
	24	Aux Contact position II: Normally Open Contact		
	63A	Motorisation module available output. Closed when the ATyS g is in Auto mode and motorisation is operational. <i>(No Fault powered and ready to changeover)</i>		
	64A			
ATS Output Contact	63B	ATS control module available output. Closed when the ATyS g is in Auto mode and ATS is operational. <i>(No Fault, powered and ready for a changeover sequence)</i>	Dry Contacts 2A AC1 / 250V	1.5 – 2.5 mm ²
	64B			
Genset Start/ Stop Signal	71	Signal to Start / Stop the Genset : Common for 72 & 74	Dry Contacts 2A AC1 / 250V	1.5 – 2.5 mm ²
	72	Signal to Start / Stop the Genset : NC contact. (71/72)		
	74	Signal to Start / Stop the Genset : NO contact. (71/74)		
Additional Aux Contact <i>Included with 2000A to 3200A</i>	81	Common for Aux Contacts positions I	Dry Contacts 2A AC1 / 250V	1.5 – 2.5 mm ²
	82	Aux Contact position I : Normally Closed Contact		
	84	Aux Contact position I : Normally Open Contact		
	91	Common for Aux Contacts positions II		
	92	Aux Contact position II : Normally Closed Contact		
	94	Aux Contact position II : Normally Open Contact		
ATS Power supply Input I	101 - L/N	Power supply I – L/N	208-277VAC±20%: 50/60Hz	1.5 – 2.5 mm ²
	102 - N/L	Power supply I – N/L		
ATS Voltage Sensing Input* Switch I	103 - 7/8	Phase or neutral connected on power contact 7 or 8 of Switch I	575 Vac (ph-ph) max 332Vac (ph-n) max	1.5 – 2.5 mm ²
	104 - 5/6	Phase connected on power contact 5 or 6 of Switch I		
	105 - 3/4	Phase connected on power contact 3 or 4 of Switch I		
	106 - 1/2	Phase or neutral connected on power contact 1 or 2 of Switch I		
ATS Power supply Input II	201 - L/N	Power supply II – L/N	208-277VAC±20%: 50/60Hz	1.5 – 2.5 mm ²
	202 - N/L	Power supply II – N/L		
ATS Voltage Sensing Input* Switch II	203 - 1/2	Phase or neutral connected on power contact 1 or 2 of Switch II	575 Vac (ph-ph) max 332Vac (ph-n) max	1.5 – 2.5 mm ²
	204 - 3/4	Phase connected on power contact 3 or 4 of Switch II		
	205 - 5/6	Phase connected on power contact 5 or 6 of Switch II		
	206 - 7/8	Phase or neutral connected on power contact 7 or 8 of Switch II		

Denomination	Terminal	Description	Characteristics	Recommended Cable Section
Motorisation Module Control Inputs	312	Remote Control Mode Enable when closed with 317	<p>Attn: Do not connect to any Power supply</p> <p>Max cable length 100m</p>	1.5 – 2.5 mm ²
	313	Position 0 order if closed with 317. (Priority order input forcing the product to remote control mode and 0 position)		
	314	Position II order if closed with 317		
	315	Position I order if closed with 317		
	316	Position 0 order if closed with 317		
	317	Common control terminal for 312 - 316 ATyS (Specific Voltage Supply)		
Remote Interface	RJ	Output to D10 remote display module	Up to 3m	RJ 45 straight cable

Denomination	Terminal	Status of the contact	Contact	Description	Characteristics	Recommended Cable Section		
ATS Module Control Inputs	207 - 208	Mains - Mains		Not used				
		Mains - Genset		Test Off Load Start: TOF	<p>Do not connect to any power supply. Attn.: To be used with dry contacts fed from 207 ONLY.</p>	1,5 – 2,5 mm ²		
			Test Off Load Stop					
	207 - 209	Mains - Mains		Priority to Source 2 (If 413-417 is open)				
				Priority to Source 1 (If 413-417 is open)				
		Mains - Genset		Test On Load Start: TON				
				Test On Load Stop				
	210			Not used				
	413 - 417	Mains - Mains		Without priority			<p>Do not connect to any power supply. Attn.: To be used with dry contacts fed from 417 ONLY.</p>	1,5 – 2,5 mm ²
				With priority				
		Mains - Genset		Priority to Test On Load				
	414 - 417	Mains - Mains		Not used				
		Mains - Genset		S2 Stability Timer (2AT) bypass				
	415 - 417	Mains - Mains and Mains - Genset		Manual retransfer				
				Automatic retransfer				
416 - 417	Mains - Mains and Mains - Genset		Automatic mode inhibition					
			AUTO Mode					

*For metering and sensing details, please refer to page 37.

 CAUTION	<p>Do not connect terminals 312 to 317, 413 to 417 or 207 to 209 to any power supply. These order inputs are powered through terminal 207 (317 or 417 respectively) and external dry contacts ONLY.</p>
--	---

7.4. Voltage sensing and power supply kit

The ATyS g voltage sensing kit is available as an accessory and is designed to tap directly of the power section on Switch I and Switch II terminals without the need to add protection fuses. The sensing kit is designed with optimised cable lengths and utilises silicon conductors held safely in an isolated mechanical support.

Frame B3 - B5 - 125A - 630A

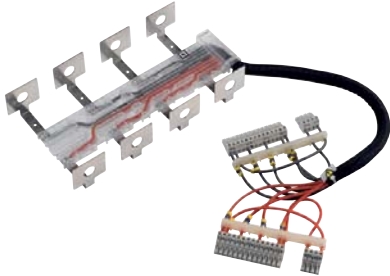

Frame B6 - B8 - 800A - 3200A

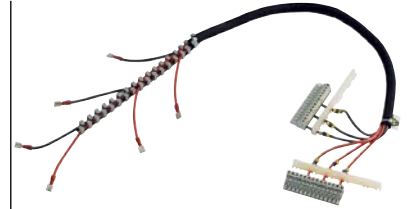

CAUTION

Ensure to mount the kit onto the product before connecting the power cables.

Be careful not to damage the contacts during kit mounting and during power cables connections (Tighten the cables carefully).

7.4.1. Standard configuration

The sensing and power supply kit may be ordered in 3 phases network 4 wires or 3 wires.

It can be used with top or bottom cables entry. The only connection to respect is that measures of the source on Switch I must be connected to the inputs located on the right of the electronic module and the measures of the source on Switch II must be connected to the inputs located on the left of the electronic module.

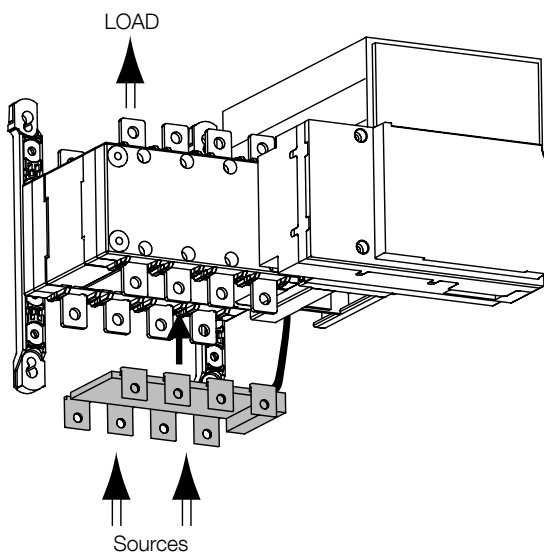

CAUTION

Pay attention when wiring the power cables (Respect to the sensing kit legend)

3 wire kits (those without a neutral) do not include for the power supply to terminals. (101-102 and 201 – 202)

Ensure that you have ordered the correct reference prior to installation.

(Refer to the accessory section for details).

7.4.2. Sensing kit wiring diagram (standard)

Bottom incoming with Top Outgoing

- Black Wires -> Switch I
- Red Wires -> Switch II

Wiring numbers:

Wire numbering has been determined in accordance to the power switch terminals

Top Incoming with Bottom Outgoing

- Black Wires -> Switch II
- Red Wires -> Switch I

Example:

Black and red wire numbers 1-2 are always connected to terminals 1 or 2 from switch I or II

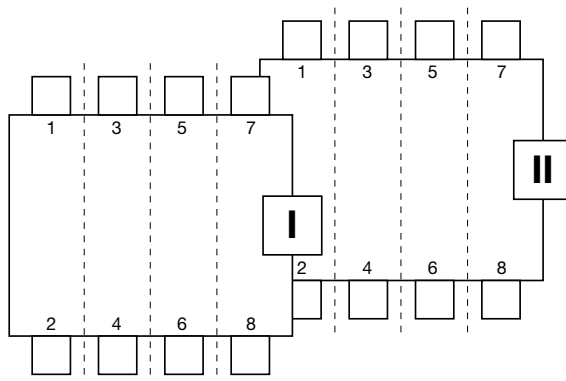

CAUTION

Verify kit orientation before mounting the kit.
Kit output cables always on the right hand side (control module side).

≤ 630A Bottom view

≥ 800A Bottom view

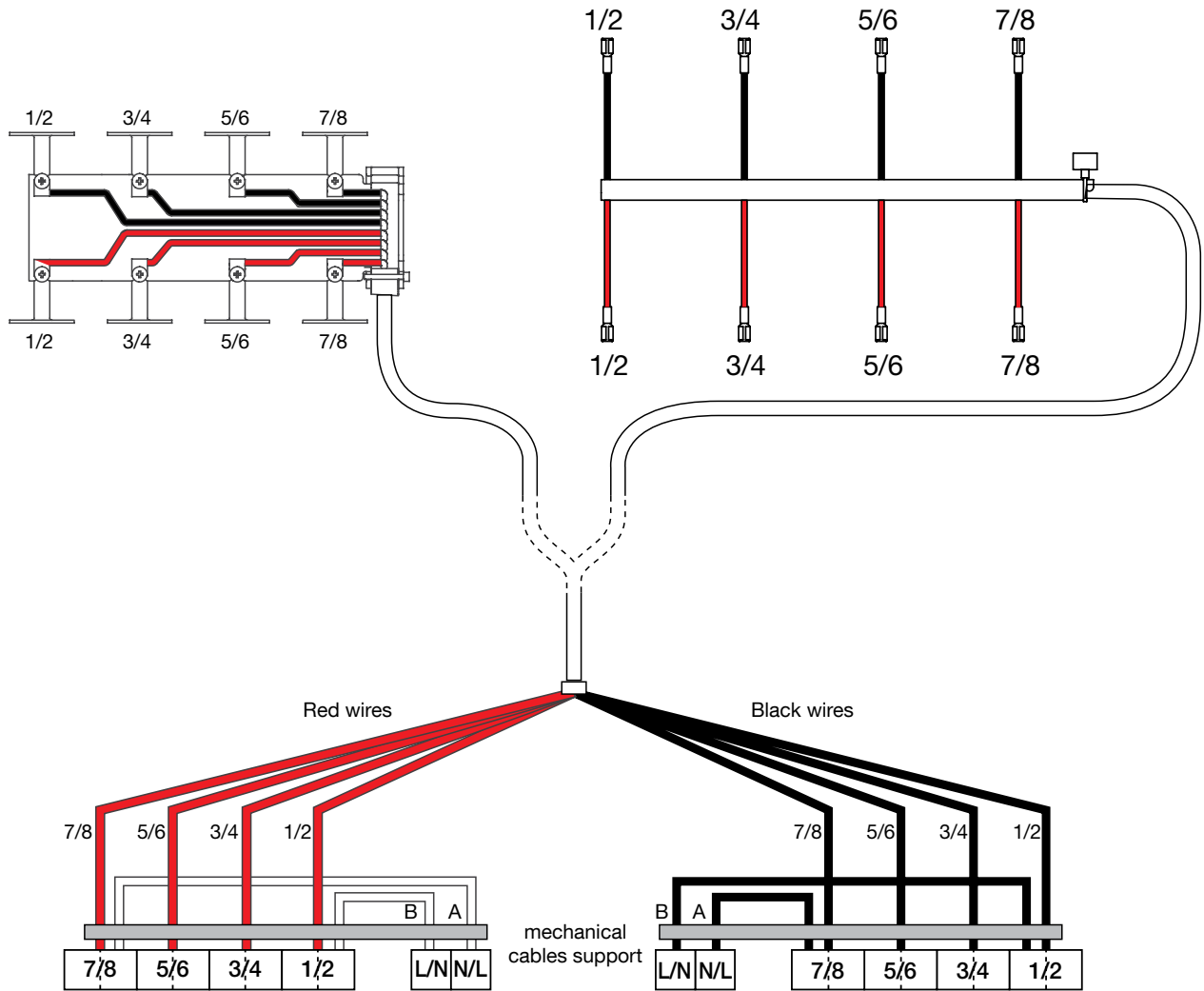

7.4.3. Network

Power inputs (terminals 101-102 & 201-202) are 220/240/277 VAC (208 - 277VAC) ± 20%. It is necessary to adapt the power input cable connections according to the network configuration. (Power supply to be taken between phase to phase or between phase and neutral).



CAUTION

Verify that the power supply between terminals 101 – 102 and 201 – 202 (nominal auxiliary voltage supply) is within 208-277VAC ± 20%.

- Standard kit:

Network 380/415 VAC ± 20% with neutral conductor (no kit modification required):

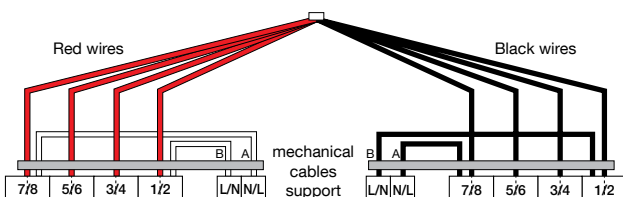

- Kit Modification:

For network 220/240 VAC ± 20%, power supply cables A-B to connect between phases

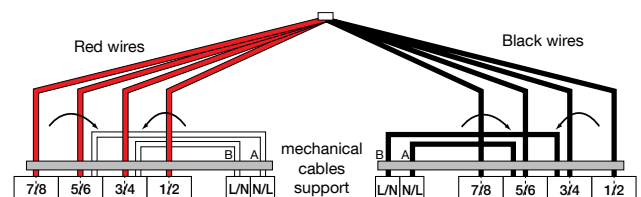













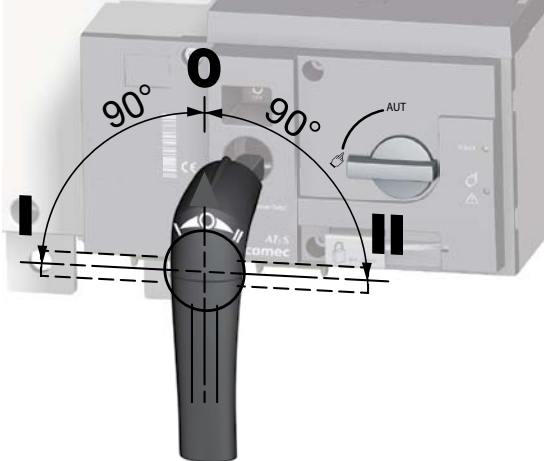



8. ATyS g OPERATING MODES

The ATyS g includes 3 safe and distinct operating modes through a selector switch located on the front of the product. As standard the ATyS g is delivered with a selector switch however a key lock type selector switch is available as accessory.

The modes of operation are as follows:

- Auto Mode: "Remotely operated transfer switching"
- Manual Mode: "Local emergency manual operation"
- Locked Mode: "Secure locked padlocking facility"

<p>AUT MODE</p>		<p>AUT</p>  	<p>AUTO MODE:</p> <ul style="list-style-type: none"> • Activates the remote control inputs and the ATS controller automation. • Inhibits the padlocking facility • Inhibits the insertion of the manual operation handle when in AUT Mode <p>AUTO Mode position is inhibited when padlocked or when the handle for manual operation is inserted into the ATyS g.</p>
<p>MODE</p> 		<p>AUT</p>  	<p>MANUAL MODE: (Not Padlocked)</p> <ul style="list-style-type: none"> • Inhibits the control inputs. • Allows to insert the handle for emergency manual operation. • Allows padlocking in O Position. <i>(With the handle for manual operation removed)</i> <p>Turning the selector switch to  from AUT and back to AUT resets a fault state.</p>
<p>MODE</p>  		<p>AUT</p>  	<p>MANUAL MODE: (Padlocked)</p> <ul style="list-style-type: none"> • Inhibits the control inputs. • Inhibits insertion of the emergency handle. • Allows padlocking when in O Position.   <p>Padlocking in position I - O and II is possible when the optional function is included in the ATyS g. (Refer to product catalogue)</p>

 **WARNING**

Depending on the state of the ATyS g the ATS automation may change the switch position as soon as the mode selector is switched to AUT. This is a normal operation.

8.1. Manual Operation

8.1.1. Emergency manual operation

The ATyS g can be manually operated as a “Manual Transfer Switch Equipment – MTSE” whilst retaining the electrical characteristics and performance of the power switching function. This function is usually used in case of emergencies or during maintenance.

To operate the ATyS g manually ensure that no live parts are accessible, turn the front selector switch into the manual position (see page 18) and insert the handle (see page 18) into the emergency handle shaft location hole provided (see page 19).

Turn the handle 90° clockwise or anti-clockwise (depending on the position to be reached) for each consecutive change in position. I -> O -> II -> O -> I.



CAUTION

Ensure to verify the product position and direction of rotation before effecting manual operation.

Ensure to remove the handle from the product before changing the selector switch back to AUT position.

8.1.2. Padlocking

The ATyS g can be padlocked in the 0 position as standard whilst padlocking in positions I, O or II is available as a factory fitted option.

To padlock the ATyS g first ensure that the ATyS g mode selector switch is on Manual then ensure that the emergency manual operation handle is not inserted into the location hole. (Remove if inserted).

Pull the padlocking mechanism outwards to reveal the slot for inserting up to 3x dia. 4 - 8mm padlocks.

Padlock the device with approved quality padlocks of minimum diameter 4mm and maximum diameter of 8mm. A maximum of 3x 8mm padlocks may be padlocked onto the ATyS g to padlocking mechanism.



CAUTION

As standard, padlocking is only made possible in the “O position”, when in manual mode and with the emergency handle not inserted.

8.2. Electrical operation

8.2.1. Dual power supply

The ATyS g includes a dual power supply and is to be powered between terminals 101 - 102 and 201 - 202 (2 different supplies - main & alternative) within the limits of: 2x 208 - 277VAC \pm 20% / (166 - 332VAC) / 50/60Hz \pm 10%.

Current Input: 100mA (Standby mode) / 15A max (Switching mode)
 Surge Protection : V_{in_sg} : 4.8KV – 1.2/50 μ s according to IEC 61010-1
 Terminal connectors: Minimum 1.5mm² / Maximum 2.5mm²

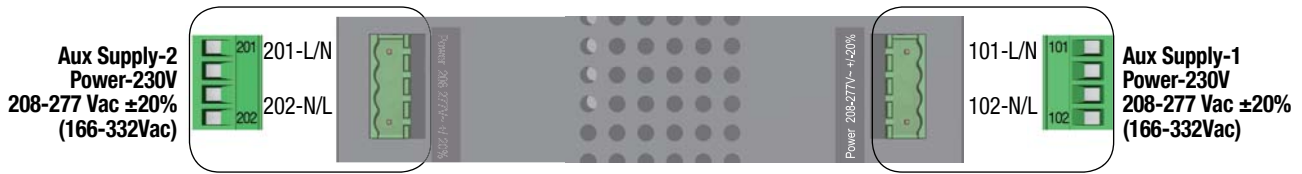

8.2.2. Voltage sensing inputs

The ATyS g includes dual single phase and three phase voltage sensing (terminals 103 - 106 and 203 - 206) designed to monitor 1Phase (L-N) supplies of up to 332VAC and 3 phase (L-L) of up to 575/600VAC.

The ATyS g is designed to handle single phase, three phase with neutral as well as three phase without neutral networks. Simply define the correct configuration of single or three phase and with or without neutral using dip switches (position A/B, C/D) on the front of the ATS controller.

Sensing connections are usually tapped directly off the ATyS g power terminals using the ATyS sensing kit available as an accessory. Sensing kits are available with the neutral on the left or neutral on the right to match the network configuration where the ATyS will be operating. Refer to the ATyS accessory section for more details.

Sensing values measured will have a direct influence on determining the availability of the main and the alternative supplies as well as the ATyS g automation.

The parameters monitored through sensing are the following:

- **Phase rotation / imbalance (3 phase networks)**
 Phase imbalance in the ATyS g is relative to the nominal voltage configured with “Auto Conf” or with the preset values on potentiometer 1 together with the voltage hysteresis value as set using Potentiometer 2.
- **Frequency within set limits**
 This will depend on the nominal frequency configured using auto conf or preset values on potentiometer 1 together with the hysteresis set using Potentiometer 2.
- **Loss of Neutral**
 When used on three phase + neutral applications (configured with dip switch 1 set on position A and dip switch 2 set on position C, the loss of neutral will be detected for most unbalanced loads. Detection will be done when the load is on.
- **Loss of the main or alternative supply**
 Loss of supply depends on the nominal voltage and frequency configured together with the hysteresis set in potentiometer 2. The supply will be considered as failed after the failure timer (set through potentiometer 3) FT on the ATS controller) has elapsed. The FT setting is adjustable from 0 – 60 seconds.
- **Return of main and / or alternative supply**
 Return of supply depends on the nominal voltage and frequency configured together with the hysteresis set. The supply will be considered as returned after the return timer (set through potentiometer 4) RT on the ATS controller has elapsed. The RT setting is adjustable from 0 – 60 minutes.

Measurement accuracy: Frequency: 0.1% - Voltage: 1%

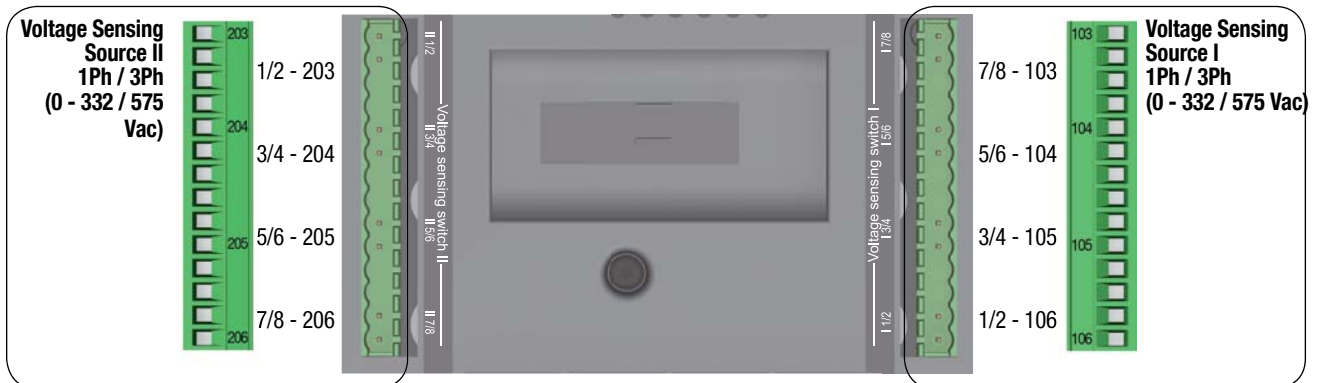

8.2.3. Fixed inputs

8.2.3.1. Description

The ATyS g includes for 5 off inputs through a 6 pin connector installed on the motorisation module. No additional power supply should be used on these contacts as the inputs MUST be used with the common supply taken from terminal 317.

The ATyS g also includes 4 additional inputs on the ATS Control Module. Again no additional power supply should be used on these contacts as the inputs MUST be used with the common supply taken from terminal 417. At least one of the ATyS g aux power supplies (101 – 102 or 201 - 202) must be available to activate inputs 312 to 317.

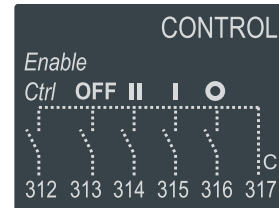

Pulse duration for activation of contact inputs: ≥ 60 ms.

- **Pin 312:** Remote Control Mode Enable when closed with 317.
This contact must be closed with 317 so as to activate all control inputs except for 313 that takes priority and is active immaterial of the state of input 312. Enabling remote control through 312 activates the remote control inputs whilst inhibiting the ATS module automation.
- **Pin 313:** Position 0 order if closed with 317 when in AUTO. (Force the switch to the OFF Position).
This is a “Priority Order Input” meaning that when closed with 317 it takes priority over all other electrical commands. The ATyS g will remain in 0 position as long as the contact 313 – 317 remains closed. Once the contact is open the ATyS g is ready to receive new orders. This contact order is independent of other inputs and is also enabled without 312 connected to 317. Impulse duration to activate and start switching to position O is a minimum of 60ms. The product state will be unavailable.
- **Pin 314:** Position II order if closed with 317.
This contact is active with the ATyS g in AUT mode with contact 312 – 317 closed and 313 – 317 open. Impulse duration to activate and switch to position II is a minimum of 60ms.
- **Pin 315:** Position I order if closed with 317.
This contact is active with the ATyS g in AUT mode with contact 312 – 317 closed and 313 – 317 open. Impulse duration to activate and switch to position I is a minimum of 60ms.
- **Pin 316:** Position 0 order if closed with 317.
This contact is active with the ATyS g in AUT mode with contact 312 – 317 closed and 313 – 317 open. Impulse duration to activate and switch to position O is a minimum of 60ms. For contactor logic maintain contacts on between terminal 316 and 317.
- **Pin 317:** Common
Common supply for inputs 312 to 316
- **Pin 413:** Input I1, Activate priority to TON/EON when closed with 417.
- **Pin 414:** Input I2 , S2 Stability Timer (2AT) bypass when closed with 417.
This input contact is used to bypass the stability timer immaterial of the state of source supply 2.
Attn: If the ATyS g auxiliary power supply is powered, this input will allow to changeover to Switch 2 even when source supply 2 is unavailable.
- **Pin 415:** Input I3, Manual Retransfer
RTC – Manual retransfer inhibits the “with priority” configuration order when closed with 417. This allows to control the retransfer back to the priority supply at a specific (less consequent) moment. This input is useful when using the “with priority” function.
- **Pin 416:** Input I4, Inhibition
This input contact inhibits the ATS automation when closed with 417 without activating any other operating modes. With inhibition active, the ATyS g may be operated in manual mode (with the direct handle) or in remote control mode with contacts 312 – 317 closed.
- **Pin 417:** Common
Common supply for fixed inputs 1 – 4 on terminals 413 to 416.

8.2.3.2. Technical data

	Motorisation Module	ATS Control Module
Input Qty	5	6
Direct Current lin	0.35 to 0.5mA	1 to 2.5mA
Line resistance	1kΩ	1kΩ
Line length	100m (Min. wire 1.5mm ² #16AWG)	100m (Min. wire 1.5mm ² #16AWG)
Pulse duration	60ms	60ms
Power per Input	0.06VA	0.03VA
Surge protection Vin_sg	4.8kV (1.2/50μs surge)	2.4kV (1.2/50μs surge)
ESD withstand voltage (Contact/air)	2/4kV	2/4kV
Insulation (Common mode)	4.8kVAC (Between I/P and all common parts)	4.8kVAC (Between I/P and all common parts)
Terminal connector	1.5mm ² minimum / 2.5mm ² max	1.5mm ² minimum / 2.5mm ² max



8.2.3.3. Remote control logic

Remote switching operation can be driven in AUT mode by external volt free contacts as described above using input contacts 312 to 317.

Depending on the wiring configuration there are two types of logic that may be applied to the ATyS g.

- Impulse logic or
- Contactor logic.

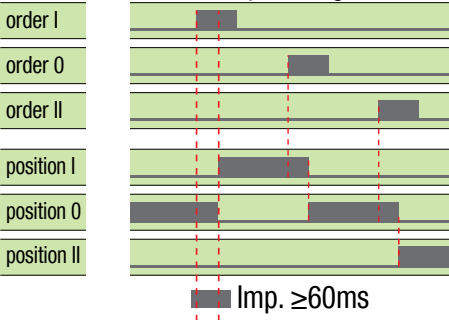
In remote control, the ATyS g inputs give priority to orders I and II over 0 therefore contactor logic can be implemented by simply bridging terminals 316 and 317.

<p>Impulse logic:</p> <p>The ATyS g is driven to a stable position (I – O – II) after receiving an impulse order.</p> <ul style="list-style-type: none"> • A switching command of at least 60 ms is necessary to initiate the switching operation. • Orders I and II have priority over order 0. <p>Note: The logic diagrams exclude the transfer times.</p>	<p style="text-align: center;">Impulse logic</p>  <p style="text-align: center;">Imp. ≥60ms</p> <p>(Note : Excludes position switching delays)</p>
<p>Contactor Logic :</p> <p>The ATyS g is driven to a specific position (I or II) for as long as the order is maintained.</p> <ul style="list-style-type: none"> • Order 0 is maintained. (Bridge 316 – 317) • Orders I and II have priority over order 0. • Orders I and II have equal priority. (1st order received is held until no longer maintained). • If order I or II disappears, the device returns to zero position. (With the power supply available). 	<p style="text-align: center;">Contactor logic</p>  <p style="text-align: center;">maintained</p> <p>(Note : Excludes position switching delays)</p>

8.2.4. Fixed outputs - Dry contacts

8.2.4.1. Description

As standard, the ATyS g is equipped with four fixed outputs located on the motorisation module.

(Dry contacts to be powered by the user).

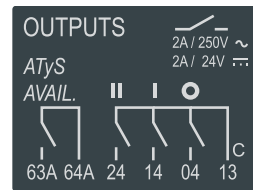

8.2.4.2. Position auxiliary contact

The ATyS g is equipped with integrated position (I – O – II) auxiliary contact outputs through 3 off micro switches.

Pins 13, 04, 14, 24

(Normally Open contacts with pin 13 as common)

8.2.4.3. ATyS g Product available output (motorisation)

Pin 63A – 64A

(Normally Open contact that is held closed when the motorisation is available).

This contact gives constant feedback about the product's availability and it's capacity to transfer from the main supply to the alternative. The feedback given is relative to the motorisation module excluding the ATS controller that may be monitored separately.

The ATyS g performs a self diagnostics test on the motorisation module at startup, when put from Manual -> Auto and then every 5 minutes. This test ensures that the ATyS g is operational in terms of control inputs. Should one of the tests fail, a second test is performed to reconfirm the error state.

Should the ATyS g motorisation module become unavailable, contact 63A – 64A are opened, the power/ready LED's are switched off, and the fault LED is activated. The fault LED will remain active for as long as sufficient power is available and the fault condition is not reset. The fault is reset when the product is switched from AUT -> Manual -> Auto mode.

ATyS g (Motorisation) Product Available / Unavailable Watchdog relay will open for any of the following reasons below: For added security, "Product Availability" is informative and does not necessarily inhibit motor operation.

Product Unavailable + Warning LED Condition:	Inhibition
Product in manual mode	Yes
Motor not detected (Autotest)	No
Control voltage out of range	Yes
Operating factor fault active (N° of operations / min)	Yes
Powerfail active	Yes
Customer input autotest failed	No
Invalid product customisation	No
Abnormal switching when not in manual mode	Yes
Requested position not reached	Yes
Locked mode active when not in manual mode	Yes
External Fault -> User input	No
Unexpected current flowing through the motor when idle	Yes

Sampling rate for the above is every 10 ms

Exception: motor detection sampling rate is every 5 min

Pin 63B – 64B

ATyS g Product Available Output (ATS module)

(Normally Open contact that is held closed when the ATS is available)

The above contacts may be used separately for precise monitoring of the state of each module or wired in series to monitor the availability of the ATS and motorisation modules as a complete unit.



8.2.4.4. Technical data

Auxiliary Contact Quantity	4
Configuration	NO
Mechanical Endurance	100k cycles
Response Time	5 – 10 ms
Startup duration	200ms
Rated Voltage / Switching Voltage	250VAC
Rated Current	2A
Surge protection Vin_sg:	4.8kV (1.2/50µs surge)
ESD withstand voltage (Contact/air):	2/4kV
Dielectric Strength contact/parts:	4.8kVAC (Reinforced Insulation)
Insulation:	4.8KVAC
Output Terminal:	1.5mm ² minimum / 2.5mm ² maximum

8.3. Programming

The ATyS g is to be programmed after wiring verification tests through the front of the ATS Controller.

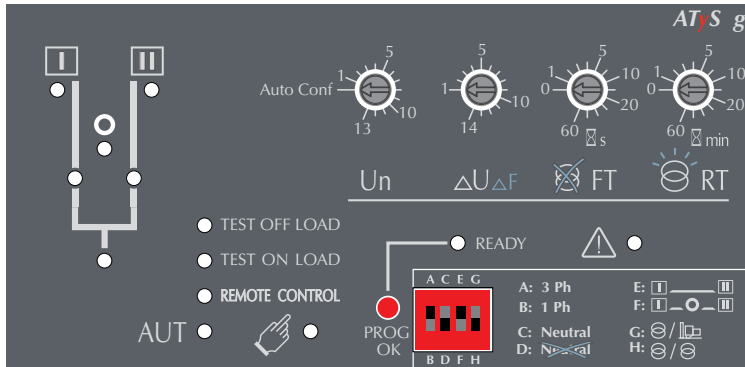

Front of ATS Controller

Un	N° PP / PN	N°: ΔU ΔF %
50 Hz	1: 220 / 127	1: 5 3
	2: 380 / 220	2: 6 3
	3: 400 / 230	3: 7 4
	4: 415 / 240	4: 8 4
	5: 480 / 277	5: 9 5
60 Hz	6: 208 / 120	6: 10 5
	7: 220 / 127	7: 11 6
	8: 230 / 132	8: 12 6
	9: 240 / 138	9: 13 7
	10: 380 / 220	10: 14 7
	11: 400 / 230	11: 15 8
	12: 415 / 240	12: 16 8
	13: 480 / 277	13: 18 9
	14: 20 10	14: 20 10

Selection chart to identify the Un and ΔU ΔF potentiometer positions. Step 2.

Programming is carried out in 5 easy steps :



Note: Ensure that the ATyS g is in “Manual Mode” with the auxiliary and network supplies available.

- **STEP 1: SET** the Dip Switch positions from “A to H” as required. (4 Dip Switches for configuration settings). *Note: The READY LED will Flash.*
- **STEP 2: SET** the potentiometers paying attention to the arrow indication. (4 Potentiometers with 14 stable positions. Un, ΔU ΔF, FT, RT)
- **STEP 3: Only if Auto Conf is selected.**
READ the network voltage and frequency. (Press the PROG OK button for >2 seconds to read the network values)
- **STEP 4: SAVE** all the configured setting values. (Potentiometers, Dipswitches and Auto Conf. (Press the PROG OK button momentarily to save: <60ms) *Note: The READY LED will stop flashing (OFF).*
- **STEP 5:** To put the unit in service Switch the ATyS g to AUT mode after STEP 4. *Note: The READY LED should turn to a Steady Green light.*

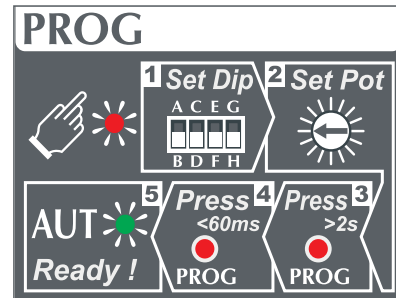

Programming cycle: 5 steps.

Attn: As a safety measure the READY LED will flash when any of the settings shown on the controller are different to those that are saved. To return to the steady READY LED revert to the saved setting values or switch to manual mode and save the displayed value by pressing the PROG OK button briefly. (This is intended as a visual alarm in case one has changed the configuration settings but has not yet saved the new values in the product)

For added security:

The ATyS g may be equipped with a sealable cover so as to limit access to the configuration settings.

Refer to the product accessory section for details.



8.3.1. Step 1: ATyS g Dip Switch Setting Options

Ensure that the product is in manual mode and SET the 4 Dip Switches using a small screw driver. Possible variants vary from positions “A to H” as described in the table below. For convenience, the position functions are also described on the front of the ATS controller adjacent to the dip switches.

Note: The READY LED will flash green as soon as settings are changed and until the new settings have been saved by pressing the PROG OK button momentarily.

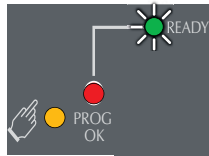
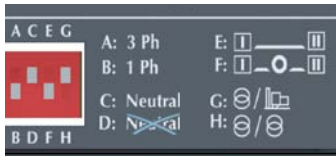

Dip Switch Setting Options		
Dipswitch 1 A / B	A	Three Phase Network
	B	Single Phase Network (Attn : Dipswitch 2 is inactive in this position)
Dipswitch 2 C / D	C	Three Phase 4 wire Network (Including Neutral) (Allows to detect a loss of neutral for unbalanced loads)
	D	Three Phase 3 wire Network (Without Neutral)
Dipswitch 3 E / F	E	Load supply down time of 0 second (ODT = 0 sec)
	F	Load supply down time of 2 seconds (ODT = 2 sec) ⁽¹⁾
Dipswitch 4 G / H	G	Main - Generator Application
	H	Main - Main Application

⁽¹⁾ When a transfer is initiated after a loss of source, the 2s time delay is counted down from the loss of source.

8.3.2. Step 2: ATyS g Potentiometer Setting Options

Ensure that the product is in manual mode and SET the 4 potentiometers using a small screw driver paying attention to the arrow indicating the position. There are a total of 14 positions for which the specific settings are described in the table below. For convenience, a table is also included on the ATS controller.

Note: The READY LED will flash green as soon as settings are changed and until the new settings have been saved by pressing the PROG OK button momentarily.

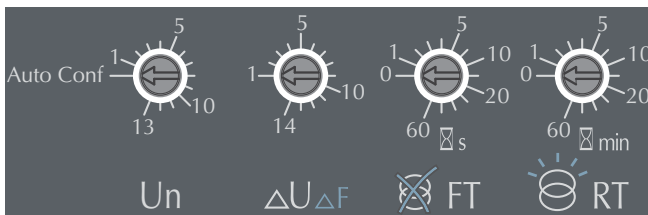

Un	N° PP / PN	N°: ΔU ΔF %
50 Hz	1: 220 / 127	1: 5 3
	2: 380 / 220	2: 6 3
	3: 400 / 230	3: 7 4
	4: 415 / 240	4: 8 4
	5: 480 / 277	5: 9 5
60 Hz	6: 208 / 120	6: 10 5
	7: 220 / 127	7: 11 6
	8: 230 / 132	8: 12 6
	9: 240 / 138	9: 13 7
	10: 380 / 220	10: 14 7
	11: 400 / 230	11: 15 8
	12: 415 / 240	12: 16 8
	13: 480 / 277	13: 18 9
	14: 20 10	14: 20 10

Refer to the selection chart to identify the Un and ΔU ΔF potentiometer position values.

Functional Description		
Potentiometer 1	Un	Pos N° 0 = Auto Configuration position Pos N° 1 to 13 = Preset Volt and Hz Config.
Potentiometer 2	ΔU ΔF	Delta U : Adjustable from 5 to 20% Delta F : Adjustable from 3 to 10%
Potentiometer 3	FT	Supply Source Failure time : 0 to 60s
Potentiometer 4	RT	Supply Source Return Time : 0 to 60 min

Potentiometer		Configuration													
Un	Position	Auto Conf	1	2	3	4	5	6	7	8	9	10	11	12	13
	PP / PN	Mesured	220 / 127V	380 / 220V	400 / 230V	415 / 240V	480 / 277V	208 / 120V	220 / 127V	230 / 132V	240 / 138V	380 / 220V	400 / 230V	415 / 240V	480 / 277V
	F	Mesured	50Hz					60Hz							
$\Delta U/\Delta F$	Position	1	2	3	4	5	6	7	8	9	10	11	12	13	14
	U threshold in % of Un	5%	6%	7%	8%	9%	10%	11%	12%	13%	14%	15%	16%	18%	20%
	F threshold in % of Fn	3%	3%	4%	4%	5%	5%	6%	6%	7%	7%	8%	8%	9%	10%
	Hysteresis	20% of $\Delta U/\Delta F$ settings													
FT	Source Failure Timer	0 sec	1 sec	2 sec	3 sec	4 sec	5 sec	8 sec	10 sec	15 sec	20 sec	30 sec	40 sec	50 sec	60 sec
RT	Source Return Timer	0 min	1 min	2 min	3 min	4 min	5 min	8 min	10 min	15 min	20 min	30 min	40 min	50 min	60 min

Note: Fixed timer settings. Source 2 genset cool down timer (2CT) is fixed at 4 minutes while source 2 failure and available timers (2FT/2AT) for Mains-Genset applications, are fixed at 5 seconds.

	WARNING	Whatever Pot 1 trimming, it is IMPERATIVE to set Pots 2 to 4.
---	---------	---

8.3.3. Step 3: ATyS g Auto Configuration

The ATyS g includes an “Auto Configuration feature to detect the mains voltage, phase rotation, neutral position and frequency nominal values and save them in the ATS controller.

Note: The voltage and frequency values may also be configured using potentiometer 1 in any suitable preset position as described in STEP 2.

Before configuring the nominal values ensure that the product is properly wired, verified and ready for commissioning. It is imperative that the network supply is available and that the wiring to the ATyS g voltage sensing terminals 103 – 106 has been done. It is preferable to use the ATyS sensing kit that may be provided as an accessory.

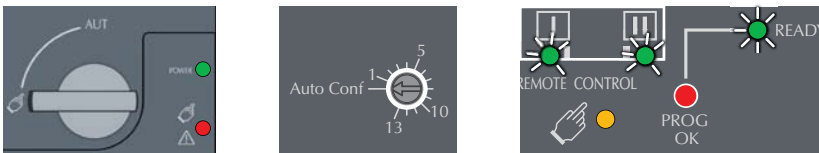

- Ensure that the product is in manual mode and set potentiometer 1 to the “Auto Conf” position.
- Press and hold the Red “PROG OK” button for >2s to measure the supply voltage, frequency, phase rotation and neutral position.

Note 1: The READY LED will flash green (on and off) as soon as settings are measured and until these settings have been saved by pressing the PROG OK button a second time momentarily. (Refer to STEP 4).

Note 2: When potentiometer 1 is not in the Auto Conf position (in other words when Voltage and Frequency are defined using positions 1 to 13) you may ignore this step.

Ensure to have both source supplies available to verify phase rotation on both source I and source II.

8.3.4. Step 4: Saving the configured values

To SAVE the recorded setting configuration press the PROG OK button momentarily: <60ms.

Note: The flashing READY LED goes off once the values are saved in the ATS controller.



8.3.5. Step 5: Putting the ATyS g into auto operation

After following Steps 1 to 4, and once ready to put the ATyS g into AUTO operation turn the mode selector switch to Auto.

Note: When the product is powered and properly configured, after switching the product from Manual Mode to Auto Mode the POWER and READY light should be a steady Green light.

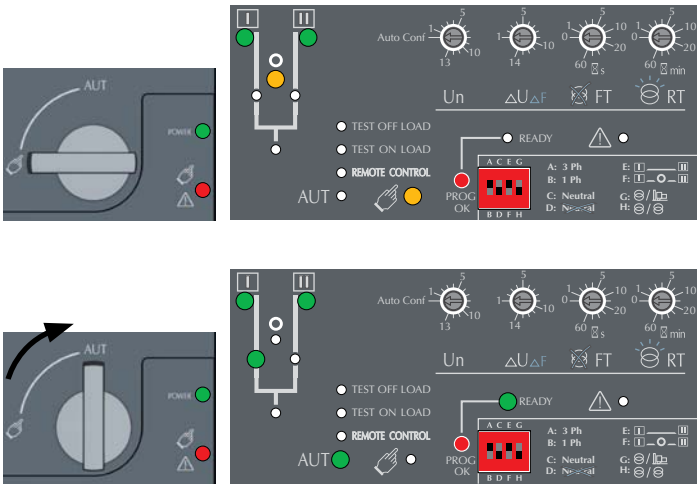

	WARNING	Depending on the state of the ATyS g the ATS automation may change the switch position as soon as the mode selector is switched to AUT. This is a normal operation.
---	---------	---

9. CHARACTERISTICS

Characteristics according to IEC 60947-3 and IEC 60947-6-1

125 to 630 A

Thermal current I_{th} to 40°C	125 A	160 A	200 A	250 A	315 A	400 A	500 A	630 A
Rated insulation voltage U_i (V) (power circuit)	800	800	800	1000	1000	1000	1000	1000
Rated impulse withstand voltage U_{imp} (kV) (power circuit)	8	8	8	12	12	12	12	12
Rated insulation voltage U_i (V) (control circuit)	300	300	300	300	300	300	300	300
Rated impulse withstand voltage U_{imp} (kV) (control circuit)	4	4	4	4	4	4	4	4

Rated operational currents I_e (A) according to IEC 60947-3

Rated voltage	Utilisation category	A/B	A/B	A/B	A/B	A/B	A/B	A/B	A/B
415 VAC	AC-21 A / AC-21 B	125/125	160/160	200/200	250/250	315/315	400/400	500/500	630/630
415 VAC	AC-22 A / AC-22 B	125/125	160/160	200/200	250/250	315/315	400/400	500/500	630/630
415 VAC	AC-23 A / AC-23 B	125/125	160/160	200/200	200/200	315/315	400/400	500/500	500/630
500 VAC	AC-21 A / AC-21 B	125/125	160/160	200/200	250/250	315/315	400/400	500/500	630/630
500 VAC	AC-22 A / AC-22 B	125/125	160/160	200/200	200/250	200/315	200/400	500/500	500/500
500 VAC	AC-23 A / AC-23 B	80/80	80/80	80/80	200/200	200/200	200/200	400/400	400/400
690 VAC	AC-21 A / AC-21 B	125/125	160/160	200/200	200/200	200/200	200/200	500/500	500/500
690 VAC	AC-22 A / AC-22 B	125/125	125/125	125/125	160/160	160/160	160/160	400/400	400/400
690 VAC	AC-23 A / AC-23 B	63/80	63/80	63/80	125/125	125/125	125/125	400/400	400/400
220 VDC	DC-21 A / DC-21 B	125/125	160/160	200/200	250/250	250/250	250/250	500/500	630/630
220 VDC	DC-22 A / DC-22 B	125/125	160/160	200/200	250/250	250/250	250/250	500/500	630/630
220 VDC	DC-23 A / DC-23 B	125/125	125/125	125/125	200/200	200/200	200/200	500/500	630/630
440 VDC ⁽¹⁾	DC-21 A / DC-21 B	125/125	125/125	125/125	200/200	200/200	200/200	500/500	630/630
440 VDC ⁽¹⁾	DC-22 A / DC-22 B	125/125	125/125	125/125	200/200	200/200	200/200	500/500	630/630
440 VDC ⁽¹⁾	DC-23 A / DC-23 B	125/125	125/125	125/125	200/200	200/200	200/200	500/500	630/630

Rated operational currents I_e (A) according to IEC 60947-6-1

Rated voltage	Utilisation category								
415 VAC	AC-31 B	125	160	200	250	315	400	500	630
415 VAC	AC-32 B				200	315	400	500	500
415 VAC	AC-33 B				200	200	200	400	400

Current rated as conditional short-circuit with fuse gG DIN, according to IEC 60947-3

Prospective fuse protected short-circuit withstand at 415 VAC(6)	100	100	50	50	50	50	50	50	50
Prospective fuse protected short-circuit withstand at 690 VAC(kA rms)	/	/	/	50	50	50	50	50	50
Associated fuse rating (A)	125	160	200	250	315	400	500	630	

Current rated as conditional short-circuit according to IEC 60947-3

Current rated as short-time withstand I_{cw} 0,3s, 415 VAC (kA rms)	12	12	12	15	15	15	17	17	
Current rated as short-time withstand I_{cw} 0,3s, 690 VAC (kA rms)	/	/	/	15	15	15	17	17	
Current rated as short-time withstand I_{cw} 1s, 415 VAC (kA rms)	7	7	7	8	8	8	10	10	
Current rated as short-time withstand I_{cw} 1s, 690 VAC (kA rms)	/	/	/	8	8	8	10	10	
Power rated as closing short-circuit I_{cm} at 415 VAC (peak kA)	11.9	11.9	11.9	22	22	22	17	17	

Current rated as conditional short-circuit according to IEC 60947-6-1

Current rated as short-time withstand I_{cw} 30 ms (kA rms), 415 VAC	10	10	10	10	10	10	/	/	
Current rated as short-time withstand I_{cw} 60 ms (kA rms), 415 VAC	/	/	/	/	/	/	10	12.6	
Power rated as closing short-circuit I_{cm} at 415 VAC (peak kA)	17	17	17	17	17	17	17	25	

Connection

Minimum Cu cable cross-section as per IEC 60947-1 (mm ²)	35	35	50	95	120	185	2 x 95	2 x 120	
Recommended Cu busbar cross-section (mm ²)							2 x 32 x 5	2 x 40 x 5	
Maximum Cu cable cross-section (mm ²)	50	95	120	150	240	240	2 x 185	2 x 300	
Maximum Cu busbar width (mm)	25	25	25	32	32	32	50	50	
Min./max. tightening torque (Nm)	9/13	9/13	9/13	20/26	20/26	20/26	40/45	40/45	

Switching time (rated voltage, after receiving command)

Time of transfer I-II or II-I (s)	0.85	0.85	0.85	0.9	0.9	0.9	0.95	0.95	
I-0 or II-0 (s)	0.55	0.55	0.55	0.5	0.5	0.5	0.55	0.55	
Time of contact transfer ("black-out" I-II) minimum (s)	0.3	0.3	0.3	0.4	0.4	0.4	0.4	0.4	

Power supply

Min./max. power (VAC)	166/332	166/332	166/332	166/332	166/332	166/332	166/332	166/332	
-----------------------	---------	---------	---------	---------	---------	---------	---------	---------	--

Control supply power demand

Demand/rated power (VA) - ATyS r, ATyS d	184/92	184/92	184/92	276/115	276/115	276/115	276/150	276/150	
Demand/rated power (VA) - ATyS t, g, p	206/114	206/114	206/114	298/137	298/137	298/137	298/172	298/172	

Mechanical specifications

Durability (number of operating cycles)	10,000	10,000	10,000	8,000	8,000	8,000	5,000	5,000	
Weight ATyS r 3 P / 4 P (kg)	5.7/ 6.9	5.7/ 6.9	5.7/ 6.9	6.6/ 7.4	6.7/ 7.8	6.7/ 7.8	11.4/ 13.3	11.9/ 14.0	
Weight ATyS d 3 P / 4 P (kg)	6.3/ 7.5	6.3/ 7.5	6.3/ 7.5	7.2/ 8.0	7.3/ 8.4	7.3/ 8.4	12.0/ 13.9	12.5/ 14.6	
Weight ATyS t, g, p 3 P / 4 P (kg)	6.8/ 8.0	6.8/ 8.0	6.8/ 8.0	7.7/ 8.5	7.8/ 8.9	7.8/ 8.9	12.5/ 14.4	13.0/ 15.1	

(1) 3-pole device with 2 „+“ poles in series and 1 „-“ pole. 4-pole device with 2 poles in series by polarity

800 to 3200 A

Thermal current I_{th} at 40°C	800 A	1000 A	1250 A	1600 A	2000 A	2500 A	3200 A
Rated insulation voltage U_i (V) (power circuit)	1000	1000	1000	1000	1000	1000	1000
Rated impulse withstand voltage U_{imp} (kV) (power circuit)	12	12	12	12	12	12	12
Rated insulation voltage U_i (V) (control circuit)	300	300	300	300	300	300	300
Rated impulse withstand voltage U_{imp} (kV) (control circuit)	4	4	4	4	4	4	4

Rated operational currents I_e (A) according to IEC 60947-3

Rated voltage	Utilisation category	A/B	A/B	A/B	A/B	A/B	A/B	A/B
415 VAC	AC-21 A / AC-21 B	800/800	1000/1000	1250/1250	1600/1600	-/2000	-/2500	-/3200
415 VAC	AC-22 A / AC-22 B	800/800	1000/1000	1250/1250	1600/1600	-/2000	-/2500	-/3200
415 VAC	AC-23 A / AC-23 B	800/800	1000/1000	1250/1250	1250/1250	-/1600	-/1600	-/1600
500 VAC	AC-21 A / AC-21 B	800/800	1000/1000	1250/1250	1600/1600	-/2000	-/2000	-/2000
500 VAC	AC-22 A / AC-22 B	630/630	800/800	1000/1000	1600/1600			
500 VAC	AC-23 A / AC-23 B	630/630	630/630	800/800	1000/1000			
690 VAC	AC-21 A / AC-21 B	800/800	1000/1000	1250/1250	1600/1600	-/2000	-/2000	-/2000
690 VAC	AC-22 A / AC-22 B	630/630	800/800	1000/1000	1000/1000			
690 VAC	AC-23 A / AC-23 B	400/400	630/630	800/800	800/800			
220 VDC	DC-21 A / DC-21 B	800/800	1000/1000	1250/1250	1250/1250			
220 VDC	DC-22 A / DC-22 B	800/800	1000/1000	1250/1250	1250/1250			
220 VDC	DC-23 A / DC-23 B	800/800	1000/1000	1250/1250	1250/1250			
440 VDC ⁽¹⁾	DC-21 A / DC-21 B	800/800	1000/1000	1250/1250	1250/1250			
440 VDC ⁽¹⁾	DC-22 A / DC-22 B	800/800	1000/1000	1250/1250	1250/1250			
440 VDC ⁽¹⁾	DC-23 A / DC-23 B	800/800	1000/1000	1250/1250	1250/1250			

Rated operational currents I_e (A) according to IEC 60947-6-1

Rated voltage	Utilisation category	800	1000	1250	1600	2000	2500	3200
415 VAC	AC-31 B	800	1000	1250	1600	2000	2500	3200
415 VAC	AC-32 B	800	1000	1250	1250	2000	2000	2000
415 VAC	AC-33 B	800	1000	800	1000	1250	1250	1250

Current rated as conditional short-circuit with fuse gG DIN, according to IEC 60947-3

Prospective fuse protected short-circuit withstand at 415 VAC (kA rms)	50	50	100	100	/	/	/
Prospective fuse protected short-circuit withstand at 690 VAC (kA rms)	50	50	50	/	/	/	/
Associated fuse rating (A)	800	1000	1250	2x800			

Current rated as conditional short-circuit according to IEC 60947-3

Current rated as short-time withstand I_{ow} 0,3s, 415 VAC (kA rms)	64	64	64	78	78	78	78
Current rated as short-time withstand I_{ow} 0,3s, 690 VAC (kA rms)	/	/	/	/	/	/	/
Current rated as short-time withstand I_{ow} 1s, 415 VAC (kA rms)	35	35	35	50	50	50	50
Current rated as short-time withstand I_{ow} 1s, 690 VAC (kA rms)	/	/	/	/	/	/	/
Power rated as closing short-circuit I_{cm} at 415 VAC (peak kA)	73,5	73,5	73,5	105	105	105	105

Current rated as conditional short-circuit according to IEC 60947-6-1

Current rated as short-time withstand I_{ow} 30 ms (kA rms), 415 VAC	/	/	/	/	/	/	/
Current rated as short-time withstand I_{ow} 60 ms (kA rms), 415 VAC	20	20	25	32	50	50	50
Power rated as closing short-circuit I_{cm} at 415 VAC (peak kA)	40	40	52.5	67.2	105	105	105

Connection

Minimum Cu cable cross-section as per IEC 60947-1 (mm ²)	2 x 185						
Recommended Cu busbar cross-section (mm ²)	2 x 50 x 5	2 x 63 x 5	2 x 60 x 7	2 x 100 x 5	3 x 100 x 5	2 x 100 x 10	3 x 100 x 10
Maximum Cu cable cross-section (mm ²)	2 x 300	4 x 185	4 x 185	6 x 185			
Maximum Cu busbar width (mm)	63	63	63	100	100	100	100
Min./max. tightening torque (Nm)	9/13	9/13	20/26	40/45	40/45	40/45	40/45

Switching time (rated voltage, after receiving command)

Time of transfer I-II or II-I (s)	2.8	2.8	2.8	2.9	2.8	2.8	2.8
I-0 or II-0 (s)	1.4	1.4	1.4	1.4	1.8	1.8	1.8
Time of contact transfer ("black-out" I-II) minimum (s)	1.4	1.4	1.4	1.5	1	1	1

Power supply

Min./max. power (VAC)	166/332	166/332	166/332	166/332	166/332	166/332	166/332
-----------------------	---------	---------	---------	---------	---------	---------	---------

Control supply power demand

Demand/rated power (VA) - ATyS r, ATyS d	460/184	460/184	460/184	460/230	812/322	812/322	812/322
Demand/rated power (VA) - ATyS t, g, p	482/206	482/206	482/206	482/252	834/344	834/344	834/344

Mechanical specifications

Durability (number of operating cycles)	4,000	4,000	4,000	3,000	3,000	3,000	3,000
Weight ATyS r 3 P / 4 P (kg)	27.9/ 32.2	28.4/ 32.9	28.9/ 33.6	33.1/ 39.4	50.7/ 61.6	50.7/ 61.6	61.0/ 75.3
Weight ATyS d 3 P / 4 P (kg)	28.5/ 32.8	29.0/ 33.5	29.5/ 34.2	33.7/ 40.0	51.3/ 62.2	51.3/ 62.2	61.6/ 75.9
Weight ATyS t, g, p 3 P / 4 P (kg)	29.0/ 33.3	29.5/ 34.0	30.0/ 34.7	34.2/ 40.5	51.8/ 62.7	51.8/ 62.7	62.1/ 76.4

(1) 3-pole device with 2 „+“ poles in series and 1 „-“ pole. 4-pole device with 2 poles in series by polarity

10. PREVENTIVE MAINTENANCE

It is recommended to verify the tightening torque of all connections and to operate the product in a full operating cycle (I – 0 – II – 0 – I: Auto and Manual) at least once a year.

Note: Maintenance should be planned carefully and carried out by qualified and authorised personnel. Consideration of the critical level and application where the product is installed should form an essential and integral part of the maintenance plan. Good engineering practice is imperative whilst all necessary precautions must be taken to ensure that the intervention (whether directly or indirectly) remains safe in all aspects.

11. TROUBLE SHOOTING GUIDE

<p>The ATyS g does not operate electrically</p>	<ul style="list-style-type: none"> • Verify the power supply on terminals 101-102 and 201-202: 208 - 277 Vac \pm20 % • Verify that the front selector switch is in position (AUT) • Verify that contacts 313 and 317 are open. • Verify that the power LED (Green) is On whilst the fault LED (RED) is off. • Verify that the Ready light on the ATS controller is a steady Green light. • Verify presence of at least one green LED on the source supply available LED's . • Verify that the product is available with contacts 63A / 64A and 63B / 64B closed. • Verify whether the problem is limited to the ATS controls + the motorisation module or just the ATS controls. <p>Note: To isolate the fault to the ATS controller or the complete unit, close contacts 312 with 317 whilst ensuring that 313 and 317 remain open. This will force the ATyS g into remote control which will bypass the ATS controller and accept position orders from contacts 314 to 317.</p>
<p>It is not possible to manually operate the switch</p>	<ul style="list-style-type: none"> • Verify that the front selector switch position is on the Manual position. • Make sure that the product is not padlocked • Verify the rotation direction of the handle • Apply a sufficient progressive action in the direction as indicated on the handle
<p>Electrical operation does not correspond to external order I,O,II</p>	<ul style="list-style-type: none"> • Verify the selected control logic wiring (impulse or contactor) • Verify the connector connections.
<p>Impossible to padlock</p>	<ul style="list-style-type: none"> • Verify that the front selector switch is in manual position • Verify that the emergency handle for manual operation is not inserted into the ATyS manual slot. • Verify that the ATyS is in 0 position • (Padlocking is only possible in 0 position for standard products)
<p>The ready light remains flashing</p>	<ul style="list-style-type: none"> • The Ready light flashes so as to indicate that the saved configuration is not identical to what is displayed on the ATS controller. This could be due to a user not yet having saved the configuration settings or that the potentiometer setting was changed and has not been saved. To get a steady READY light either revert to the settings in the ATyS g or save the new settings. To save put into manual mode and press the PROG OK button momentarily.
<p>The AUT light is flashing</p>	<ul style="list-style-type: none"> • The AUT LED will be steady green when in AUTO Mode and will be flashing green when the ATyS g has timers running. • This is usually a normal indication.
<p>The fault LED is ON (Motorisation)</p>	<ul style="list-style-type: none"> • The FAULT / MANUAL LED on the motorisation module is on when in manual mode (this is normal) and in AUT Mode when there is an internal fault in the ATyS g. To reset a fault condition switch the ATyS g from AUT to Manu and back to AUT. Should the fault LED remain on you will need to localize and clear the fault prior to reset. • The FAULT / Manual LED will also be on when contact 313 is closed with 317. (Force the ATyS to off position). This is a normal condition. • The FAULT LED will also illuminate when the aux power supply is present but out of range. • Should the Fault LED remain on abnormally, contact SOCOMEC.
<p>The fault LED is on (ATS Controller)</p>	<ul style="list-style-type: none"> • Switch the ATyS g from AUT to Manual and back to AUT. Should the fault condition remain contact SOCOMEC)
<p>Sources availability LEDs and fault LED are blinking</p>	<ul style="list-style-type: none"> • Check phase rotation consistency between both sources. • Check neutral position consistency between both sources.

12. ACCESSORIES

12.1. Terminal shrouds

Use

IP2X protection against direct contact with terminals or connecting parts.

Advantages

Perforations allow remote thermographic inspection without the need to remove the shrouds.

Rating (A)	Frame size	No. of poles	Position	Reference
125 ... 200	B3	3 P	top / bottom / front (I) / rear (II)	2694 3014 ⁽¹⁾⁽²⁾
125 ... 200	B3	4 P	top / bottom / front (I) / rear (II)	2694 4014 ⁽¹⁾⁽²⁾
250 ... 400	B4	3 P	top / bottom / front (I) / rear (II)	2694 3021 ⁽¹⁾⁽²⁾
250 ... 400	B4	4 P	top / bottom / front (I) / rear (II)	2694 4021 ⁽¹⁾⁽²⁾
500 ... 630	B5	3 P	top / bottom / front (I) / rear (II)	2694 3051 ⁽¹⁾⁽²⁾
500 ... 630	B5	4 P	top / bottom / front (I) / rear (II)	2694 4051 ⁽¹⁾⁽²⁾

(1) To shroud front switch top and bottom 2 references required.

(2) To fully shroud front, rear, top and bottom 4 references required.



access_206_a_2_cat

12.2. Terminal screens

Use

Top and bottom protection against direct contact with terminals or connection parts.

For upstream and downstream protection, order the reference once.

Rating (A)	Frame size	No. of poles	Position	Reference
125 ... 200	B3	3 P	top / bottom	1509 3012
125 ... 200	B3	4 P	top / bottom	1509 4012
250 ... 400	B4	3 P	top / bottom	1509 3025
250 ... 400	B4	4 P	top / bottom	1509 4025
500 ... 630	B5	3 P	top / bottom	1509 3063
500 ... 630	B5	4 P	top / bottom	1509 4063
800 ... 1250	B6	3 P	top / bottom	1509 3080
800 ... 1250	B6	4 P	top / bottom	1509 4080
1600	B7	3 P	top / bottom	1509 3160
1600	B7	4 P	top / bottom	1509 4160
2000 ... 3200	B8	3 P	top / bottom	1509 3200
2000 ... 3200	B8	4 P	top / bottom	1509 4200



access_207_a_2_cat

12.3. Bridging bars

Use

For bridging power terminals on the top or bottom side of the switch. One piece required per pole.

Rating (A)	Frame size	No. of poles	Section (mm)	Reference
125 ... 200	B3	3 P	20 x 2.5	4109 3019
125 ... 200	B3	4 P	20 x 2.5	4109 4019
250	B4	3 P	25 x 2.5	4109 3025
250	B4	4 P	25 x 2.5	4109 4025
315 ... 400	B4	3 P	32 x 5	4109 3039
315 ... 400	B4	4 P	32 x 5	4109 4039
500	B5	3 P	32 x 5	4109 3050
500	B5	4 P	32 x 5	4109 4050
630	B5	3 P	50 x 5	4109 3063
630	B5	4 P	50 x 5	4109 4063
800 ... 1000	B6	3 P	50 x 6	4109 3080
800 ... 1000	B6	4 P	50 x 6	4109 4080
1250	B6	3 P	60 x 8	4109 3120
1250	B6	4 P	60 x 8	4109 4120
1600	B7	3 P	90 x 10	4109 3160
1600	B7	4 P	90 x 10	4109 4160



access_205_a_2_cat

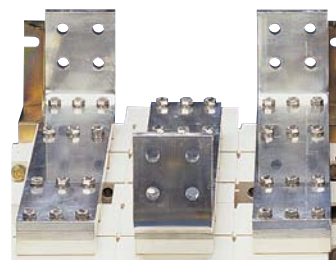

access_041_a_1_cat

12.4. Copper bar connection kits

Use

Enables:

- connection between the two power terminals of the same pole for 2000 to 3200 A ratings (Fig. 1 and Fig 2)
- up or downstream bridging connection (Fig. 3).

For 3200 A rating, the connection pieces (part A) are delivered bridged from factory. Bolt sets must be ordered separately.

Further details for these specific accessories are available in the user guide downloadable from www.socomec.com.

The numbers given in the table below refer to the contact connection.

	Part number	2000 – 2500 A			3200 A		
		Fig. 1		Fig. 3	Fig. 1		Fig. 3
		Connection	Flat	Onsite	Outage bridge I and II	Connection	Flat
Connection part A	2619 1200	1	1	2 ⁽²⁾	included	included	included
Screw kit 35 mm part B	2699 1201	1 ⁽¹⁾		2 ⁽²⁾	1 ⁽¹⁾		2 ⁽²⁾
Screw kit 45 mm part B	2699 1200	1 ⁽¹⁾			1 ⁽¹⁾		
T + screw kit part C	2629 1200		1	1		1	1
Bracket + screw kit part D	2639 1200		1			1	
Bar + screw kit part E	4109 0320			1			1

Then multiply the quantity by the number of contacts you need.

⁽¹⁾ Choose the right length according to the width of the bars in place. If more than 20 mm, use 45 mm screws.

⁽²⁾ For the bridging setup you need 2 parts for each pole as the contacts of units I and II are connected.

For example, for a 4 P 2500 A with onsite upstream connection (Fig. 2) and downstream bridging (Fig. 3), please order

16 x 2619 1200 12 x 2629 1200
 8 x 2699 1201 4 x 4109 0320
 8 x 2639 1200

Fig. 1

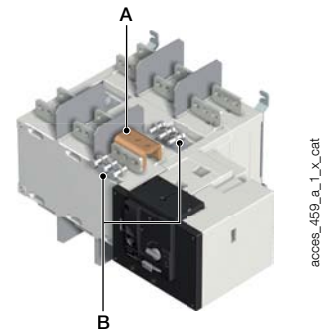

Fig. 2

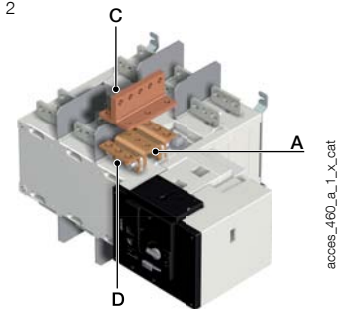
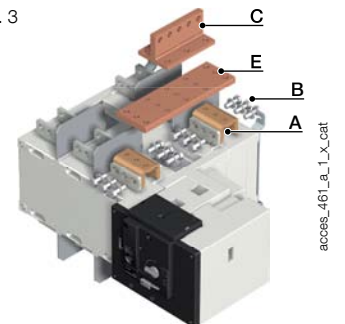

Fig. 3



12.5. Solid neutral

Use

The connection kit enables the connection between the input and output neutrals, without any need to switch the neutral.

Rating (A)	Frame size	Reference
125 ... 200	B3	9509 0012
200 ... 315	B4	9509 0025
400	B4	9509 0040
500 ... 630	B5	9509 0063
800 ... 1000	B6	9509 0080
1250	B6	9509 0120
1600	B7	9509 0160

12.6. Autotransformer 400/230 VAC

Use

For applications without neutral, this autotransformer provides the 230 VAC required to power these ATyS products.

Rating (A)	Frame size	Reference
125 ... 3200	B3 ... B8	1599 4064

12.7. DC power supply

Use

Allows an ATyS to be supplied from a 12, 24 or 48 VDC source.
To be positioned as close as possible to the DC power supply source.

Rating (A)	Frame size	Operating voltage	Reference
125 ... 3200	B3 ... B8	12 VDC / 230 VAC	1599 5012
125 ... 3200	B3 ... B8	24 VDC / 230 VAC	1599 5112
125 ... 1600	B3 ... B7	48 VDC / 230 VAC	1599 5212

12.8. Voltage sensing and power supply kit

Use

For power supply and voltage measurement (4 wire, three-phase) for the ATyS t, g and p.

Routing of the conductors is controlled, which means that no specific protective device is necessary for these connections.

The kit can be fitted on the top or bottom of the switch.

Note: the 3-pole version does not integrate the power supply.

From 125 to 630 A

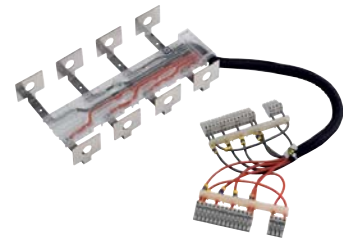

atys_606_a_1_cat

From 800 to 3200 A

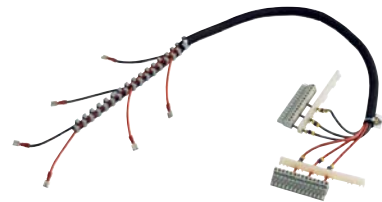

atys_603_a_2_cat

For ATyS t, g and p - 3 poles

Rating (A)	Frame size	Reference
125 ... 200	B3	1559 3012
250	B4	1559 3025
315 ... 400	B4	1559 3040
500 ... 630	B5	1559 3063
800 ... 1000	B6	1559 3080
1250	B6	1559 3120
1600	B7	1559 3160
2000 ... 3200	B8	1559 3200

For ATyS t, g and p - 4 poles

Rating (A)	Frame size	Reference
125 ... 200	B3	1559 4012
250	B4	1559 4025
315 ... 400	B4	1559 4040
500 ... 630	B5	1559 4063
800 ... 1000	B6	1559 4080
1250	B6	1559 4120
1600	B7	1559 4160
2000 ... 3200	B8	1559 4200

12.9. Voltage relay

Use

The ATyS DS is a voltage relay for monitoring a three-phase power supply source.

The fault relay will close as soon as a fault is detected on the supply being monitored.

Rating (A)	Reference
DS	192X 0056



atys_762_a_1_cat

12.10. Door protective surround

Use

When direct access to the ATyS front face (mode selection, manual operation, display....) is required, the door surround can be utilised to provide a clean and safe finish to the panel's cut-out.

For ATyS r

Rating (A)	Frame size	Reference
125 ... 630	B3 ... B5	1529 0012
800 ... 3200	B6 ... B8	1529 0080

For ATyS d, t, g and p

Rating (A)	Frame size	Reference
125 ... 630	B3 ... B5	1539 0012
800 ... 3200	B6 ... B8	1539 0080

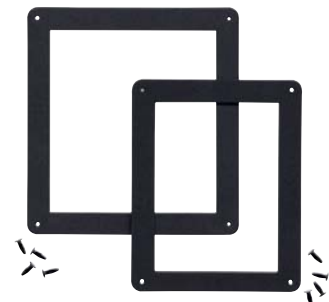

atys_595_a_2_cat

12.11. Auxiliary contacts (additional)

Use

Pre breaking and signalling of positions I and II: each reference provides a single factory or customer fitted NO/NC contacts for both positions.

Low level auxiliary contacts: please consult us.

Rating (A)	Frame size	Nominal current (A)	Operating current I _o (A)			
			250 VAC AC-13	400 VAC AC-13	24 VDC DC-13	48 VDC DC-13
125 ... 3200	B3 ... B8	16	12	8	14	6

Rating (A)	Frame size	Type of mounting	Reference
125 ... 630	B3 ... B5	Customer fitted	1599 0502 ⁽¹⁾
800 ... 1600	B6 ... B7	Customer fitted	1599 0532 ⁽¹⁾
2000 ... 3200	B8	-	included

(1) Up to 2 auxiliary contacts can be ordered.



125 to 630 A



800 to 1600 A

access_397_a

access_396_a

12.12. Mounting spacers

Use

Increases the distance between the rear power terminals and the backplate by 1 cm per spacer.

This accessory may also be used to replace the original mounting spacers.

Rating (A)	Frame size	Description of accessories	Reference
125 ... 630	B3 ... B5	1 set of 2 spacers	1509 0001



atys_009_b_2_cat

12.13. 3 position padlocking (I - 0 - II)

Use

Enables the ATyS to be padlocked in the 3 positions 0, I and II (factory fitted).

Rating (A)	Frame size	Reference
125 ... 630	B3 ... B5	9599 0003
800 ... 3200	B6 ... B8	9599 0004



12.14. RONIS Key interlocking system

Use

With the product in manual mode, it enables locking in position 0 using a RONIS EL11AP lock (factory fitted).

As standard, locking in position 0.

Optional padlocking in 3 positions: locking in position I, 0 or II.

Rating (A)	Frame size	Reference
125 ... 630	B3 ... B5	9599 1006
800 ... 3200	B6 ... B8	9599 1004



atys_968_a

12.15. Remote interface

Use

To remotely display source availability and position indication typically used on the front of a panel when the product is enclosed.

Interfaces are powered from the ATyS transfer switch via the RJ45 connection cable.

Maximum cable length: 3 m.

D10 - for ATyS d, t and g

To display source availability and position indication on the front panel of an enclosure. Protection degree: IP21.

D20 - for ATyS p

In addition to the functions of the ATyS D10, the D20 displays measurements and enables control and configuration from the front of a panel.

Protection degree: IP21.

Door mounting

2 holes Ø 22.5. ATyS transfer switch connection via RJ45 cable, not isolated. Cable available as an accessory.



atys_564_d_1_cat

atys_565_d_1_cat

Interfaces are powered from the ATyS



atys_597_a_1_cat

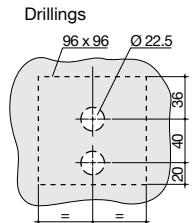

atys_161_a_1_x_cat

Description of accessories	Reference
D10	9599 2010
D20	9599 2020

12.16. Connection cable for remote interface

Use

To connect between a remote interface (type D10 or D20) and an ATyS transfer switch (ATyS d, t, g or p).

Characteristics

For ATyS d, t, g and p		
Type	Length	Reference
RJ45 cable	3 m	1599 2009

RJ45 8 wire straight-through, non isolated cable. Length 3m.



access_209_a_2_cat

12.17. Sealable cover

Use - for ATyS t and g

Prevents access to the ATyS t and g configuration potentiometers and DIP switches (seals supplied).

Rating (A)	Frame size	Reference
125 ... 3200	B3 ... B8	9599 0000



atys_870_a

12.18. Auto/Manual key selector

Use

Replaces the standard Auto/Manual selector knob with a key selector, providing added security by preventing unauthorised use of product. Customer assembly required.

Rating (A)	Frame size	Reference
125 ... 3200	B3 ... B8	9599 1007



atys_869_a

13. Spare parts

13.1. Electronic module

The electronic module of ATyS d, t, g and p can be easily replaced in case of problems, even when the load is supplied.

Product model	References
ATyS d	9539 2001
ATyS t	9549 2001
ATyS g	9559 2001
ATyS p	9579 2001



atys_601_c_1_gp_cat

13.2. Motorisation module

The motorisation module of ATyS r, d, t, g and p can be easily replaced in case of problems, even when the load is supplied.

Rating	References
125 ... 200 A	9509 5020
250 ... 400 A	9509 5040
500 ... 630 A	9509 5063
800 ... 1250 A	9509 5120
1600 A	9509 5160
2000 ... 3200 A	9509 5320



atys_871_a

13.3. Power section

References to be used for replacing the switching module of ATyS r, d, t, g or p. Please contact SOCOMEC.

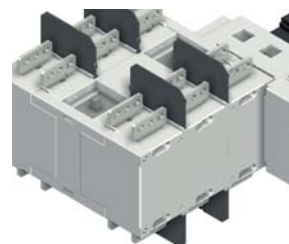

14. ATYS Family: ORDERING INFORMATION

The following is an ordering guide for ATYS Motorised Transfer Switches delivered inclusive of the emergency handle and storage clip. This guide is intended so as to explain the logic behind SOCOMEC ATYS reference numbers.

When ordering please consult the latest SOCOMEC catalogue.

Typical UL 1008 (Optional Standby Power) ATYS reference



97 2 3 4 0 1 0

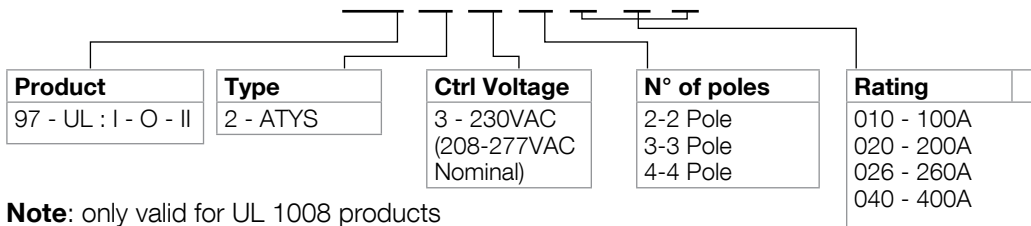

Note: only valid for UL 1008 products

Typical IEC 60947-6-1 ATYS reference



95 2 3 4 0 6 3

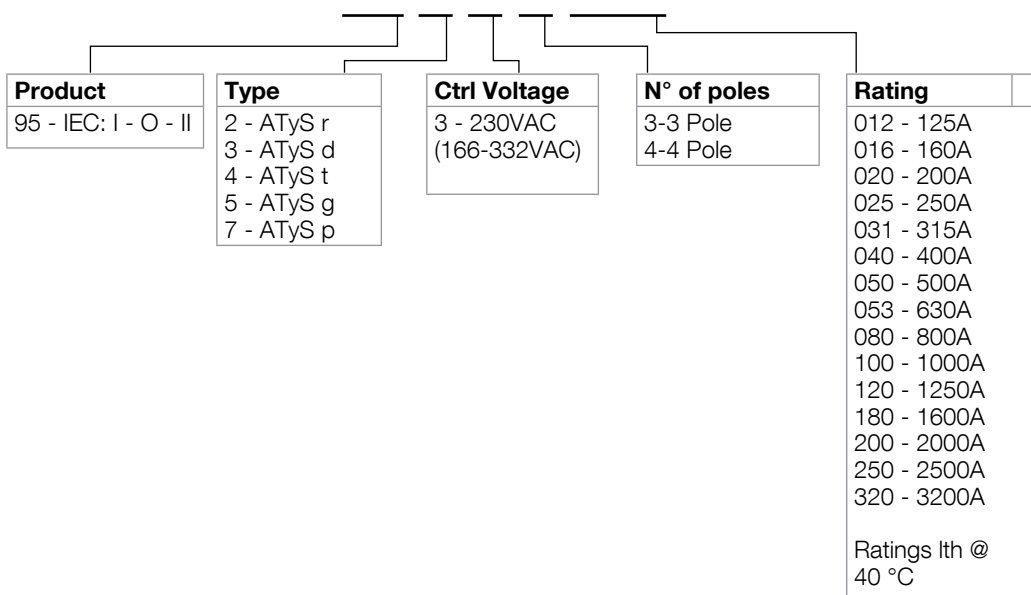

CORPORATE HQ CONTACT:
SOCOMECSAS
1-4 RUE DE WESTHOUSE
67235 BENFELD, FRANCE

www.socomec.com



541 998 C - EN - 11/16

 **socomec**
Innovative Power Solutions